

LYNX

Security System

Installation and Setup Guide

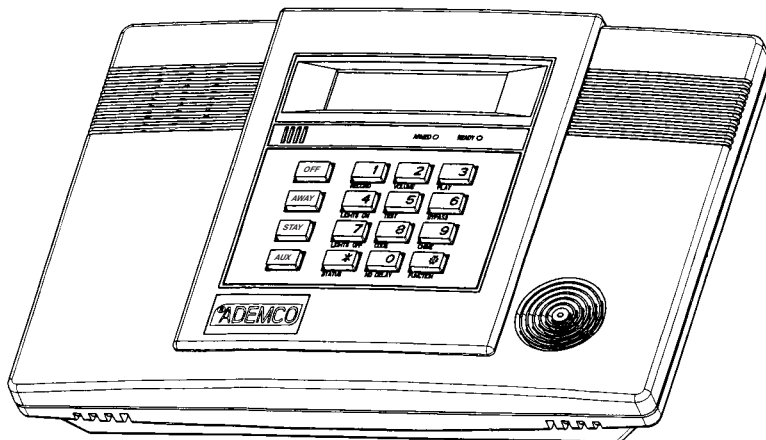

RECOMMENDATIONS FOR PROPER PROTECTION

The Following Recommendations For The Location Of Fire And Burglary Detection Devices Help Provide Proper Coverage For The Protected Premises.

Recommendations For Smoke And Heat Detectors

With regard to the number and placement of smoke/heat detectors, we subscribe to the recommendations contained in the National Fire Protection Association's (NFPA) Standard #72 noted below.

Early warning fire detection is best achieved by the installation of fire detection equipment in all rooms and areas of the household as follows: For minimum protection a smoke detector should be installed outside of each separate sleeping area, and on each additional floor of a multi-floor family living unit, including basements. The installation of smoke detectors in kitchens, attics (finished or unfinished), or in garages is not normally recommended.

For additional protection the NFPA recommends that you install heat or smoke detectors in the living room, dining room, bedroom(s), kitchen, hallway(s), attic, furnace room, utility and storage rooms, basements and attached garages.

In addition, we recommend the following:

- Install a smoke detector inside every bedroom where a smoker sleeps.
- Install a smoke detector inside every bedroom where someone sleeps with the door partly or completely closed. Smoke could be blocked by the closed door. Also, an alarm in the hallway outside may not wake up the sleeper if the door is closed.
- Install a smoke detector inside bedrooms where electrical appliances (such as portable heaters, air conditioners or humidifiers) are used.
- Install a smoke detector at both ends of a hallway if the hallway is more than 40 feet (12 meters) long.
- Install smoke detectors in any room where an alarm control is located, or in any room where alarm control connections to an AC source or phone lines are made. If detectors are not so located, a fire within the room could prevent the control from reporting a fire or an intrusion.

THIS CONTROL COMPLIES WITH NFPA REQUIREMENTS FOR TEMPORAL PULSE SOUNDING OF FIRE NOTIFICATION APPLIANCES.

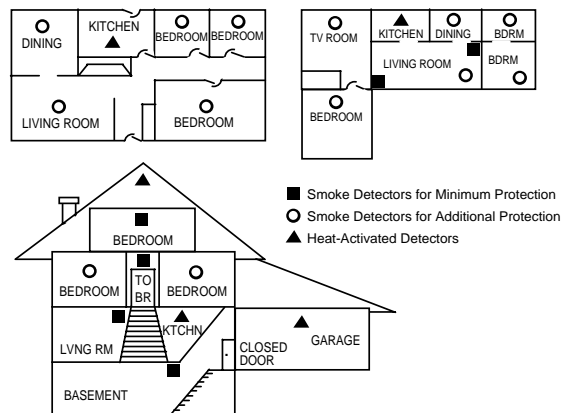

Recommendations For Proper Intrusion Protection

For proper intrusion coverage, sensors should be located at every possible point of entry to a home or premises. This would include any skylights that may be present, and the upper windows in a multi-level building.

In addition, we recommend that radio backup be used in a security system so that alarm signals can still be sent to the alarm monitoring station in the event that the telephone lines are out of order (alarm signals are normally sent over the phone lines, if connected to an alarm monitoring station).

Table of Contents

SYSTEM FEATURES	4
MOUNTING THE CONTROL	5
WIRING CONNECTIONS	6
AC POWER AND BACKUP BATTERY	8
INSTALLING WIRELESS ZONES	9
MECHANICS OF PROGRAMMING	12
ZONE RESPONSE TYPE DEFINITIONS	13
DATA FIELD DESCRIPTIONS	15
*56 ZONE PROGRAMMING MODE	21
*80 DEVICE (Powerline Carrier) PROGRAMMING MENU MODE.....	24
*81 ZONE LIST MENU MODE	27
*83 SEQUENTIAL MODE	28
*84 ASSIGN ZONE VOICE DESCRIPTORS	29
VOICE VOCABULARY INDEX.....	30
*85 RECORD CUSTOM VOICE DESCRIPTORS.....	30
REMOTE PROGRAMMING/CONTROL (DOWNLOADING)	31
SYSTEM OPERATION	32
TESTING THE SYSTEM	35
SYSTEM COMMUNICATION	36
TROUBLESHOOTING GUIDE.....	38
REGULATORY AGENCY STATEMENTS	40
SPECIFICATIONS	41
PROGRAMMING DEFAULT TABLES	42
LIMITATIONS OF THIS SYSTEM STATEMENT.....	46
SUMMARY OF CONNECTIONS DIAGRAM	47
WARRANTY	Back cover

System Features

The LYNX is a self-contained, wireless control/communicator that features easy installation and usage. Its built-in speaker provides voice announcement of system status along with voice descriptors of each zone (if programmed). The following illustration highlights the main features of this system.

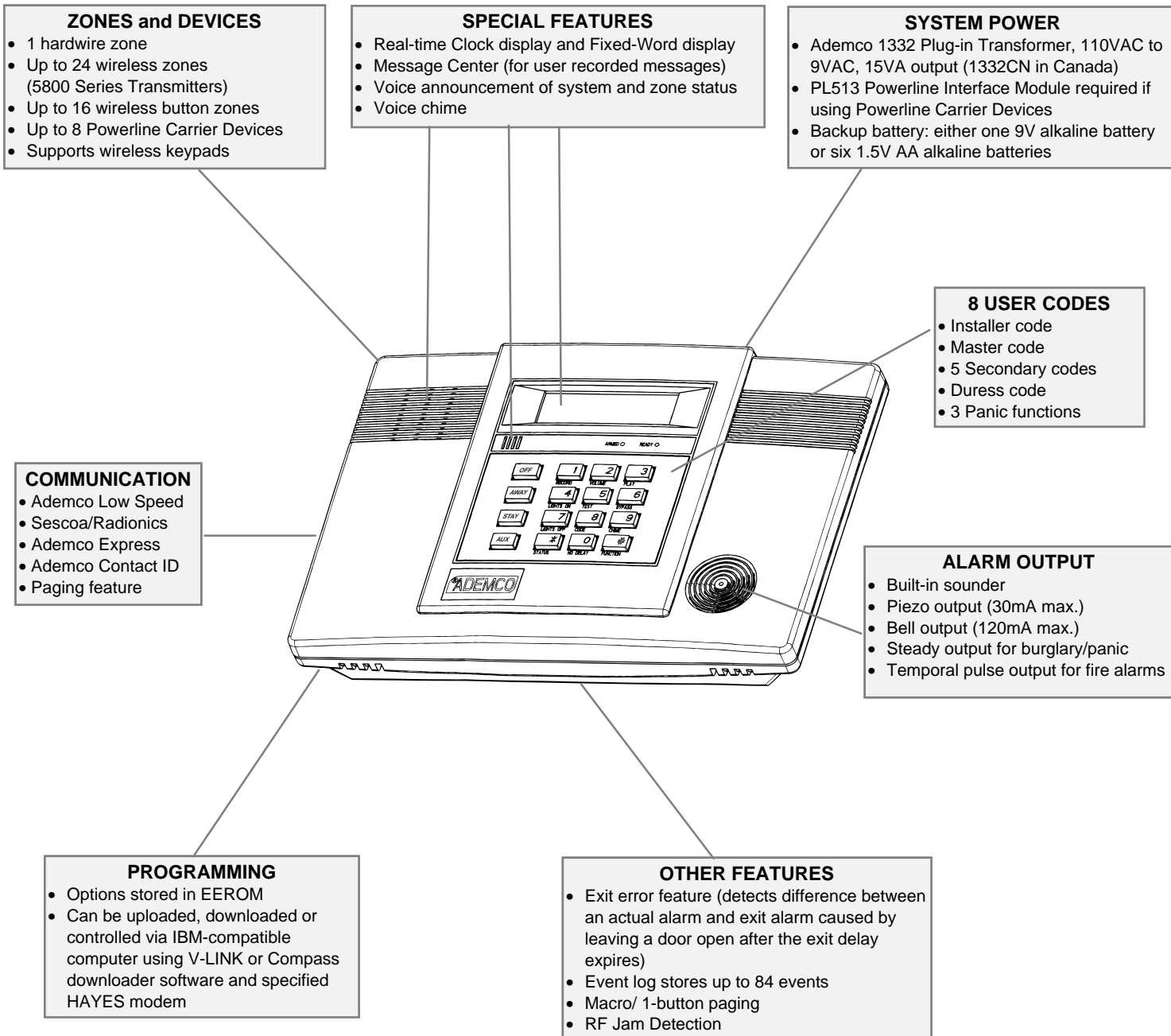

Mounting the Control

Wall Mounting

The illustration below shows the front assembly separated from the back plate.



DO NOT disconnect the ribbon cable from the terminal strip board. Disconnect the cable only from the front assembly board.

1. Separate the front assembly from the back plate by pressing on the two locking tabs at the top of the unit, and carefully disconnect the ribbon cable from the front assembly, **leaving the ribbon cable connected to the terminal block PC board**. The back plate contains the terminal block for making wiring connections.

2. Mount the back plate to a sturdy wall, feeding the field wiring through the opening in the back plate.

3. After wiring connections are made, carefully reconnect the ribbon cable to the front assembly PC board connector (properly aligning the red wire), then snap the front assembly to the back plate so it is held by the locking tabs.

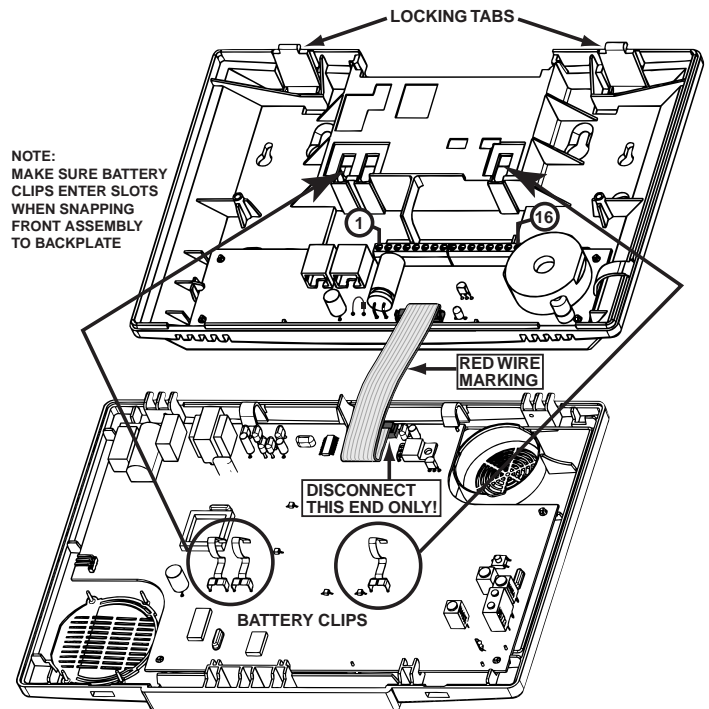

Desktop Mounting

If desired, an optional mounting base (model LYNX-DM, purchased separately) allows the LYNX to be used on a desktop.

1. Slide the LYNX onto the mounting base locking tabs.

2. Bring all wiring through the bottom of the mounting base, using one of the three wire entry locations, before making connections to the LYNX.

3. Use tie-wraps to secure the wiring to the built-in wire loops as needed. Use the two supplied screws to secure the LYNX to the mounting

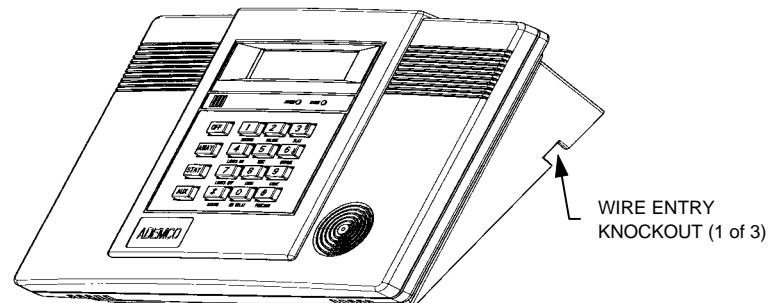

Wiring Connections

Wiring Overview

The following summarizes the connections required. Refer to the Wiring Connections paragraph on the next page and the Summary of Connections diagram on the inside back cover when making connections.

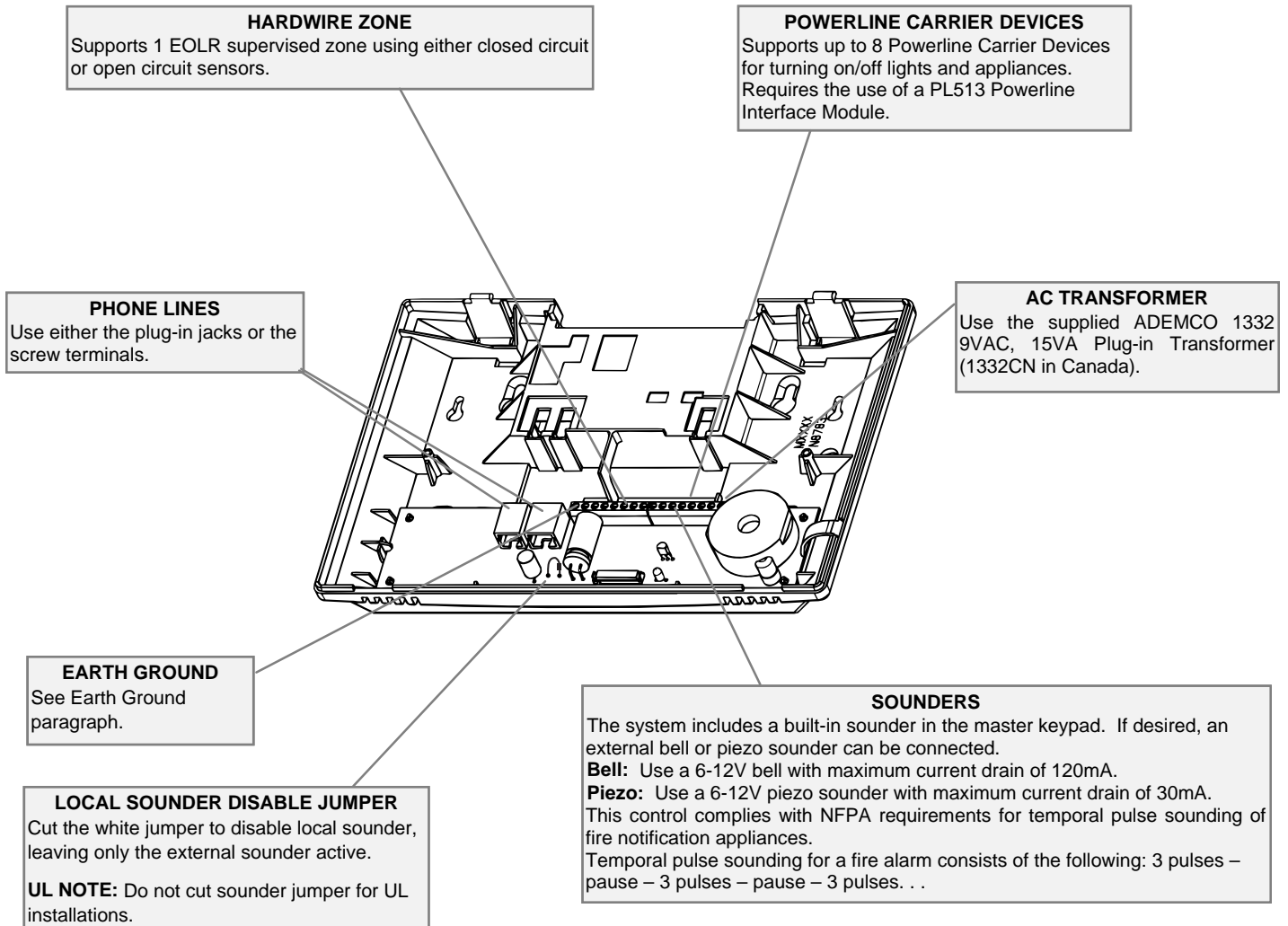

Earth Ground Considerations

Connect terminal 1 to a good earth ground.

The designated earth ground terminal (1) must be terminated in a good earth ground for the lightning transient protective devices in this product to be effective. The following are examples of good earth grounds available at most installations:

Metal Cold Water Pipe: Use a noncorrosive metal strap (copper is recommended) firmly secured to the pipe to which the ground lead is electrically connected and secured.

AC Power Outlet Ground: Available from 3-prong, 120VAC power outlets only. To test the integrity of the ground terminal, use a three-wire circuit tester with neon lamp indicators, such as the UL Listed Ideal Model 61-035, or equivalent, available at most electrical supply stores.

Wiring Connections

Wiring Connections

1. Phone Line Connections

For local line seizure, connect the incoming phone line to either the 8-position jack or terminals 2 (TIP) and 3 (RING), then connect the handset phone lines to either the RJ11 jack or terminals 4 (TIP) and 5 (RING).

For full line seizure, the control must be placed in **series** with the incoming phone line. This is easily done using an RJ31X connection jack as shown.

With the Direct Connect Cord plugged into the RJ31X jack, the control can seize the phone line when an alarm occurs. If the plug needs to be removed, the RJ31X allows normal phone line usage by the premises phones.

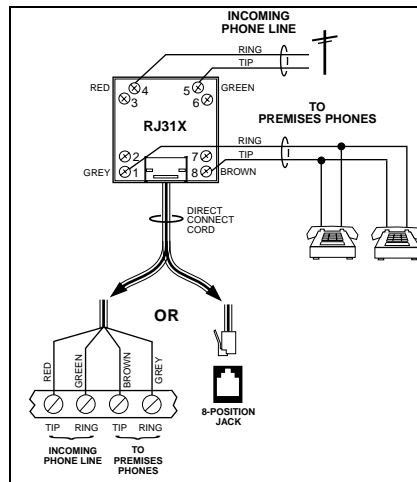

Full Line Seizure Connections

1. Cut the incoming RING and TIP phone lines (typically red and green, respectively) and connect to RJ31X terminals 4 (red) and 5 (green).
2. Connect the premises end of the cut RING and TIP wires to RJ31X terminals 1 (grey) and 8 (brown) respectively.
3. Wire the flying leads of a Direct Connect Cord to the control's phone terminals as shown in the diagram or plug into the 8-position jack.
4. Plug the Direct Connect Cord into the RJ31X jack.

2. Hardwired Zone Connections

Zone 1 is an EOLR supervised zone that supports both open circuit and closed circuit devices and has a response time of 350msec.

Maximum zone resistance: 300 ohms, plus EOLR

The hardwire zone cannot be used as a fire zone.

- a. Connect sensors/contacts to the hardwired zone terminals 6 (+) and 7 (-). Refer to the Summary of Connections diagram.
- b. Connect closed circuit devices in series in the high (+) side of the loop. The EOL resistor must be connected in series with the devices, following the *last device*.
- c. Connect open circuit devices in parallel across the loop. The 2000 ohm EOLR must be connected across the loop *at the last device*.

3. External Sounder Connections

The LYNX supports either a 6-14VDC piezo sounder (30mA max.) or 6-14VDC bell (120mA max.; e.g. ADEMCO WAVE2EX).

Connect a piezo sounder to terminals 10 (+) and 11 (-);

OR

Connect a bell to terminals 11 (-) and 12 (+).

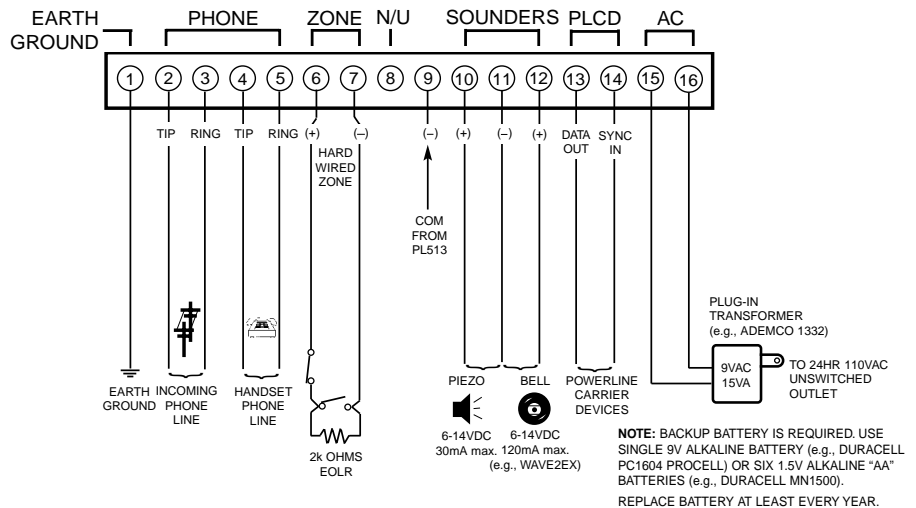

LYNX Terminal Block

4. Powerline Carrier Device Connections

The LYNX supports up to 8 Powerline Carrier Devices.

If using these devices, the LYNX requires connection of a PL513 Powerline Interface Module, as shown in the SUMMARY OF CONNECTIONS diagram.

Connect the com/data/sync/ lines from the PL513 Powerline Interface Module to terminals 9, 13, and 14, respectively. If not using the supplied Ademco connection cable, you may need to reverse the black and yellow wire connections.

Refer to the **80 Device Programming Menu Mode* section for details on programming Powerline Carrier Devices.



HARDWIRED ZONE: If the EOLR is not at the end of the loop, the zone will not be properly supervised, and the system may not respond to an open circuit on the zone.



LOCAL SOUNDER DISABLE: The Master Keypad's built-in piezo sounder can be disabled by cutting the white jumper on the terminal board. If disabled, no sounding will occur upon AC loss, since the external sounder does not operate when AC power is lost.

UL NOTE: Do not cut sounder jumper for UL installations.

AC Power and Backup Battery

The LYNX is powered by a 9VAC, 15VA Plug-in Transformer, ADEMCO 1332 (1332CN in Canada).

Refer to the wiring table below for wire gauge and length.

Distance of Transformer from the Control	Wire Gauge to Use
Up to 75 feet	#20
75 to 150 feet	#18
150 to 300 feet	#16

Backup battery is required. In the event of an AC power loss, the Control is supported by a long life, readily available, non-rechargeable backup battery.

The system uses either a single 9-volt alkaline battery (e.g., Duracell PC1604 Procell) or six 1.5V “AA” alkaline batteries (e.g., Duracell MN1500). Select the appropriate battery(ies) based on the installation’s UL requirement. Install the batteries in the battery drawer as shown below.

The battery is supervised for connection and for low voltage conditions. If the battery is missing, or a low battery condition is detected, a “low battery” message is displayed and a report is sent to the central station. In addition, the system will beep once every 45 seconds to audibly indicate a low battery condition (press any key to stop the beeping).

Battery Standby Time: single 9V battery = 4 hours; six 1.5V “AA” batteries = 24 hours



Wiring to the AC Transformer must not exceed 300 feet using 16 gauge wire. The voltage reading between terminals 15 and 16 of the control must not fall below 9.00VAC.

Do not plug the transformer into the AC outlet until after all wiring connections have been made.



For UL985, you must use six 1.5V “AA” alkaline batteries (Duracell MN1500 only).

1. Connect wires from the 1332 AC Transformer to terminals 15 and 16 as shown in the wiring diagram. After all wiring connections have been made, plug the transformer into a 24-hour 110VAC unswitched outlet.

2. Slide out the battery drawer. Install either a single 9V alkaline battery or six 1.5V “AA” alkaline batteries. Use only non-rechargeable, alkaline batteries. After installing the battery(ies), slide the battery drawer into the back plate **only after** AC power has been applied.

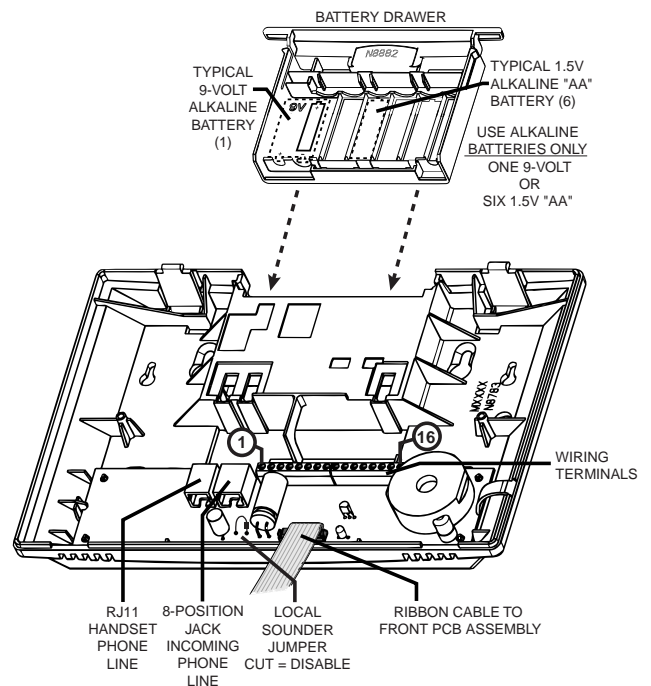

DO NOT slide the battery drawer with batteries installed back into the unit until after AC power has been applied.

Installing Wireless Zones

General Information

Zones: The control supports up to 24 wireless zones using 5800 Series transmitters, and up to 16 wireless buttons.

Range: The built-in RF receiver can detect signals from wireless transmitters within a nominal range of 200 feet.

Transmitters: 5800 Series transmitters have built-in serial numbers that must be entered into the system using the *56 or *83 interactive mode, or input to the control via the downloader. 5800 Series transmitters (except the 5827, described separately) do not have DIP switches.

Each transmitter's zone number is programmed into the system in *56 mode. Some transmitters, such as the 5816 and 5817, can support more than one "zone" (referred to as loops or inputs). On the 5816, for example, the wire connection terminal block is loop 1, the reed contact is loop 2. Each loop must be assigned a different zone number.

UL The 5816 and 5817 Transmitters do not have EOL supervision of their loop wiring. Therefore, for UL Household Burglary installations, the loop wiring may not exceed 3 feet.

For button transmitters (RF "keys") such as the 5804 and 5801, you must assign a unique zone number to each individual button used on the transmitter. Each button on the transmitter also has a pre-designated loop or input number, which is automatically displayed.

House Identification

If you are using a 5804BD, 5827 or 5827BD Wireless Keypad with the system, you must program a House ID Code (01–31) in field *24 to establish proper communication, and the keypad must be set to the same ID. House ID 00 disables all wireless keypads. An RF House ID is not necessary for other 5800 Series transmitters; the entry should be left at "00" (default) in those cases.

The 5827 reports low battery status as zone "00."

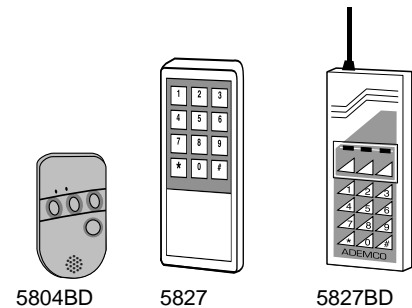

Transmitter Supervision

Except for some transmitters/keypads that may be carried off-premises (5802, 5802CP, 5804, 5804BD, 5827, and 5827BD), each transmitter is supervised by a check-in signal that is sent to the receiver at 70–90 minute intervals. If at least one check-in is not received from each supervised transmitter within a 12-hour period, the "missing" transmitter number(s) and "FAULT" will be displayed.

The supervision for a particular transmitter in the system that may also be carried off the premises (5801, 5802MN) may be turned off by entering it as a "UR" (unsupervised RF) type, as described in the *56 *Zone Programming Mode* section.

5800 Series transmitters have built-in tamper protection and will annunciate as a fault condition if covers are removed.



Transmitter Input Types

All of the transmitters described have one or more unique factory-assigned input (loop) ID codes. Each of the inputs requires its own programming zone (e.g., a 5804's four inputs require four programming zones).

Transmitters can be entered as one of the following types (see transmitter's instructions for appropriate input type):

Type	Description
"RF" (Supervised RF)	Sends periodic check-in signals, as well as fault, restore, and low battery signals. The transmitter must remain within the receiver's range.
"UR" (Unsupervised RF)	Sends all the signals that the "RF" type does, but the control does not supervise the check-in signals. The transmitter may therefore be carried off-premises.
"BR" (Unsupervised Button RF)	These only send fault signals. They do not send low battery signals until they are activated. The transmitter may be carried off-premises.

Transmitter Battery Life

- Batteries in the wireless transmitters may last from 4–7 years, depending on the environment, usage, and the specific wireless device being used. Factors such as humidity, high or low temperatures, as well as large swings in temperature may all reduce the actual battery life in a given installation. The wireless system can identify a true low battery situation, thus allowing the dealer or user of the system time to arrange a change of battery and maintain protection for that point within the system.
- Some transmitters (e.g., 5802, 5802CP) contain long-life but nonreplaceable batteries, and no battery installation is required. At the end of their life, the complete unit must be replaced (and a new serial number entered by the control).
- Button-type transmitters (eg., 5801, 5802, 5802CP) should be periodically tested for battery life.
- The 5802MN and 5804 button transmitters have replaceable batteries.

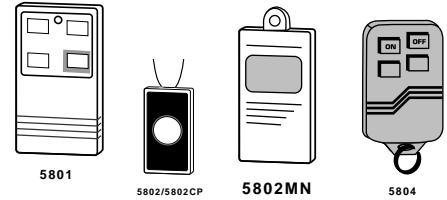

Using the Transmitter Sniffer Mode

Use this mode after all transmitters have been entered to check that all transmitters have been properly programmed.

1. Enter **Installer code (4112) + # + 3**.

NOTE: If the communicator is in the process of sending a report to the central station, the system will not go into the Sniffer mode. If so, wait a few minutes and try again.

2. The keypad will display all zone numbers of wireless units programmed into the system. Fault each transmitter in turn, causing each one to send a signal. As the system receives a signal from each of the transmitters, the zone number of that transmitter will **disappear** from the display. The transmitters may be checked upon installation, or in an installed system.
3. When all transmitters have been checked, exit the Sniffer mode by keying **Installer Code (4112) + OFF**.

NOTES:

- Sniffer mode does not automatically expire. You must manually exit (Installer Code + OFF) Sniffer mode to return to normal operation. Sniffer mode also terminates if a user arms the system.
- All BR-type units must physically be activated to clear the display, since they do not automatically send check-in signals.
- When **one** button of a transmitter (RF, UR, or BR) is activated, all zones assigned to other buttons on that transmitter are cleared. This also applies to 5816 and 5817 transmitters which have multiple loops (zones).
- Any transmitter that is not “entered” will not turn off its zone number.

Go/No Go Test Mode

The Go/No Go tests will verify adequate RF signal strength from the proposed transmitter location, and allow you to reorient or relocate transmitters if necessary, before mounting the transmitters permanently.

This mode is similar to the transmitter Test mode, except that the wireless receiver gain is reduced. This will enable you to make sure that the RF signal from each transmitter is received with sufficient signal amplitude when the system is in the normal operating mode.

1. Enter **Installer Code (4112) + [#] + 8**.
2. Once you have placed transmitters in their desired locations and the approximate length of wire to be run to sensors is connected to the transmitter's screw terminals (if used), fault each transmitter. Do not conduct this test with your hand wrapped around the transmitter, as this will cause inaccurate results.

NOTE: On button type transmitters whose buttons have been set to Arm AWAY, Arm STAY, or Disarm, pressing a button will take the system out of the Go/No Go Test mode and cause that action.

 - a. The keypad will beep three times to indicate signal reception and display the appropriate zone number.
 - b. If the keypad does not beep, reorient or move the transmitter to another location. Usually a few inches in either direction is all that is required.
4. If each transmitter produces the proper keypad response when it is faulted, you can then permanently mount each of the transmitters according to the instructions provided with them.
5. Exit the Go/No Go Test mode by entering: **Installer Code (4112) + OFF**.

5800 Series Transmitter Loop Numbers

The following illustration shows the compatible transmitters and their associated input types and loop designations. Refer to this information when programming transmitters.

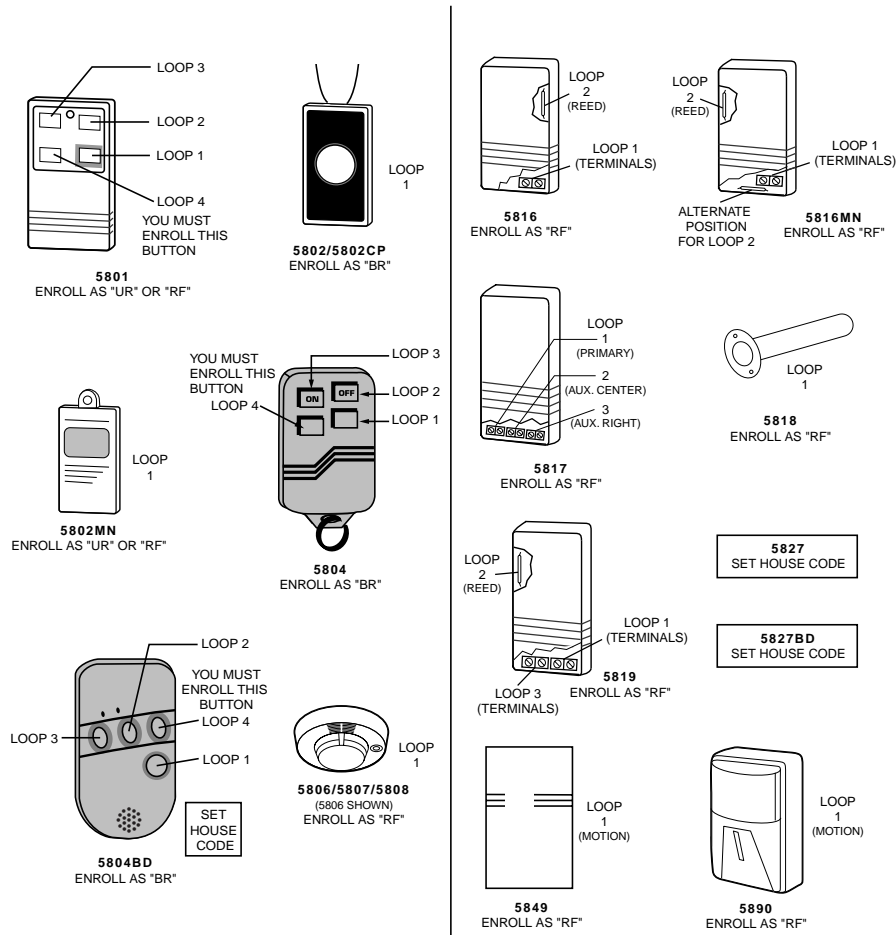

NOTE: You must enroll loop 4 on the 5801, 5804 and 5804BD transmitters, regardless of whether the other loops are being used.

Setting DIP Switches on the 5827 Transmitter(s)

Set all 5827 Transmitters to the programmed House ID, using its DIP switches.

5827 Wireless Keypad DIP Switch Table

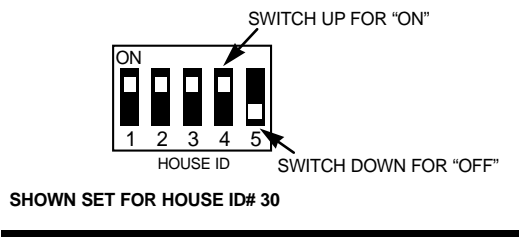

HOUSE ID	DIP SWITCH POSITION				
	1	2	3	4	5
1	-	-	-	-	UP
2	-	-	-	UP	-
3	-	-	-	UP	UP
4	-	-	UP	-	-
5	-	-	UP	-	UP
6	-	-	UP	UP	-
7	-	-	UP	UP	UP
8	-	UP	-	-	-
9	-	UP	-	-	UP
10	-	UP	-	UP	-
11	-	UP	-	UP	UP
12	-	UP	UP	-	-
13	-	UP	UP	-	UP
14	-	UP	UP	UP	-
15	-	UP	UP	UP	UP
16	UP	-	-	-	-

HOUSE ID	DIP SWITCH POSITION				
	1	2	3	4	5
17	UP	-	-	-	UP
18	UP	-	-	UP	-
19	UP	-	-	UP	UP
20	UP	-	UP	-	-
21	UP	-	UP	-	UP
22	UP	-	UP	UP	-
23	UP	-	UP	UP	UP
24	UP	UP	-	-	-
25	UP	UP	-	-	UP
26	UP	UP	-	UP	-
27	UP	UP	-	UP	UP
28	UP	UP	UP	-	-
29	UP	UP	UP	-	UP
30	UP	UP	UP	UP	-
31	UP	UP	UP	UP	UP

Mechanics of Programming

General Programming Information

Programming options are stored in nonremovable, electrically erasable, nonvolatile EEROM memory.

You can program the system at any time, even at the installer's premises prior to the actual installation. Simply apply power temporarily to the Control and then program the unit as desired.

There are two programming modes:

- Data field programming (used for setting various system options)
- Interactive menu mode programming (used for programming zone information, programming Powerline Carrier Devices, and for entering transmitter serial numbers)

You can also program this system remotely, using an IBM Personal Computer, a modem, and V-LINK downloading software or Compass Downloader for Windows. See the *Remote Programming/Control (Downloading)* section.

Entering Program Mode

You may use one of the following methods:

a) Press both the [*] and [#] keys at the same time **within 50 seconds** after power is applied to the Control or from exiting Programming mode, OR

b) After power-up, enter the **Installer Code (4 1 1 2) + 8 0 0**. (This method disabled if exit Program mode using *98.)

If a different Installer Code is subsequently programmed, use it instead of 4112 to enter the Programming mode.

Following entry into Program mode, data field *20 will be displayed (this is the first data field in the system) and both keypad LEDs will flash.

Programming a Data Field

1. Press [*] + **Field No.** (for example, *21), then make the required entry.
2. When you have completely programmed a data field, the keypad will “beep” three times and then automatically display the next data field in sequence. To go to a different field, press [*] plus the desired field number.
3. If the number of digits that you need to enter in a data field is less than the maximum number of digits available (eg. phone number field), enter the desired data, then press [*] to program the next data field.
4. If you enter a nonexistent field, the keypad will display “EE”. Simply re-enter [*] plus a valid field number.

To view a data field without making changes, press [#] + **Field No.** Data will be displayed for that field.

To delete an entry in a field, press [*] + **Field No.** + [*]. (Applies only to fields *40–*44, *88 and *94).

Interactive Mode Programming (*56, *80, *81, *83, *84, *85)

Press [*] + **interactive mode No.** (for example, *56). The keypad will display the first of a series of prompts.

A detailed procedure (with displays of prompts) is provided in later sections of this manual.

Interactive Mode	Used to Program
------------------	-----------------

*56 Zone Programming	Zone characteristics, report codes, and serial numbers
*80 Device Programming	Powerline Carrier Devices
*81 Zone List Programming	Zone Lists for powerline carrier activation
*83 Sequential Mode	5800 Series transmitter serial numbers
*84 Assign Zone Voice Descriptors	Voice descriptors for each zone
*85 Record Custom Voice Descriptors	Up to 5 custom voice descriptors for zones

Loading Factory Defaults

To load the factory defaults, enter the Programming mode, press *97, then press number 1, 2, 3, 4 or 5 to select from default tables 1-5 at the back of this manual, or press “0” to exit without selecting a default.



If loading a default table, any data already programmed into the system will be changed according to the default table selected!

*96 resets all the subscriber account numbers and CSID in preparation for an initial download.

Exiting Program Mode

*99 allows re-entry into the Program mode using **Installer Code + 8 0 0**.

*98 inhibits re-entry into the Programming mode using the Installer Code.

NOTE: After exiting program mode (or upon power-up), the system takes up to a minute to reset. To bypass the reset delay, press [#] + [0].

Zone Response Type Definitions

General Information

During programming, you must assign a zone type to each zone, which defines the way in which the system responds to faults in that zone. Zone types are defined below.

Type 00 Program a zone with this zone type if the zone is not used.
Zone Not Used

Type 01
Entry/Exit Burglary #1



This zone type provides exit and entry delays whenever the zone is faulted if the control is armed in the AWAY or STAY mode. When the panel is armed in the INSTANT or MAXIMUM mode, no entry delay is provided. Entry delay #1 is programmable from 0-99 seconds (field *35).

Exit delay begins whenever the control is armed, regardless of the arming mode selected, and is independently programmable from 0-99 seconds (field *34).

This zone type is usually assigned to sensors or contacts on doors through which primary entry and exit will take place.

Type 02
Entry/Exit Burglary #2



This zone type provides a secondary entry delay whenever the zone is faulted if the panel is armed in the AWAY or STAY mode. When the panel is armed in the INSTANT or MAXIMUM mode, no entry delay is provided. Entry delay #2 is programmable from 0-99 seconds (field *36).

The programmed exit delay (field *34) begins whenever the control is armed, regardless of the arming mode selected.

This zone type is usually assigned to sensors or contacts on doors through which secondary entry and exit will take place, and where more time might be needed to get to and from the keypad (typically used for a garage, loading dock, or basement door).



Type 03
Perimeter Burglary

This zone type gives an instant alarm if the zone is faulted when the panel is armed in the AWAY, STAY, INSTANT, or MAXIMUM mode. This zone type is usually assigned to all sensors or contacts on exterior doors and windows.

Type 04
Interior, Follower

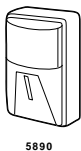

This zone type gives a delayed alarm (using the programmed entry/exit time) if the entry/exit (types 01 or 02) or interior-with-delay (type 10) zone is faulted first. Otherwise this zone type gives an instant alarm. This zone type is active when the panel is armed in the AWAY or MAXIMUM mode. **This zone type is bypassed automatically when the panel is armed in the STAY or INSTANT mode.** This zone type is usually assigned to a zone covering an area such as a foyer, lobby, or hallway through which one must pass upon entry (after faulting the entry/exit zone to reach the keypad to disarm the system).

Since this zone type is designed to provide an instant alarm if the entry/exit zone is not violated first, it will protect an area in the event an intruder hides on the premises prior to the system being armed, or gains access to the premises through an unprotected area.

Type 05
**Trouble by Day/
Alarm by Night**

This zone type will give an instant alarm if faulted when armed in the AWAY, STAY, INSTANT or MAXIMUM (night) mode. During the disarmed state (day), the system will provide a latched trouble sounding from the keypad (and a central station report, if desired). This zone type is usually assigned to a zone which contains a foil-protected door or window (such as in a store), or to a zone covering a "sensitive" area such as a stock room, drug supply room, etc. This zone type can also be used on a sensor or contact in an area where immediate notification of an entry is desired.

Type 06
24-hour Silent Alarm

This zone type sends a report to the central station but provides no keypad display or sounding. This zone type is usually assigned to a zone containing an Emergency button.

Type 07
24-hour Audible Alarm

This zone type sends a report to the central station, and provides an alarm sound externally and at the keypad. This zone type is usually assigned to a zone that has an Emergency button.



Type 08
24-hour
Auxiliary Alarm

This zone type sends a report to the central station and provides an alarm sound at the keypad. (No bell output is provided and there is no keypad timeout.) This zone type is usually assigned to a zone containing a button for use in personal emergencies, or to a zone containing monitoring devices such as water or temperature sensors, etc.

Type 09
Supervised Fire

This zone type provides a fire alarm on short circuit and a trouble condition on open circuit. The bell output will pulse when this zone type is alarmed. This zone type is always active and cannot be bypassed. Any wireless zone can be used as a fire zone.

Type 10
Interior w/Delay

This zone type gives entry delay #1 (using the programmed entry time) if tripped when the panel is armed in the AWAY mode. Entry delay begins whenever sensors in this zone are violated, regardless of whether an entry/exit delay zone was tripped first. *No entry delay* is provided if tripped when the panel is armed in the MAXIMUM mode. *Exit* delay is present for *any* arming mode. **This zone type is bypassed when the panel is armed in the STAY or INSTANT mode.**

Type 20
Arm-Stay

This is a special-purpose zone type used with 5800 Series wireless pushbutton units which will result in arming the system in the STAY mode when the zone is activated. Pushbutton units send the zone number as a user number to the central station when arming or disarming.

Type 21
Arm-Away

This is a special-purpose zone type used with 5800 Series wireless pushbutton units which will result in arming the system in the AWAY mode when the zone is activated. Pushbutton units send zone number as a user number to central station when arming or disarming.

Type 22
Disarm

This is a special-purpose zone type used with 5800 series wireless pushbutton which will result in disarming the system when the zone is activated.

Type 23
No Alarm Response

This zone type can be used on a zone when a Powerline Carrier Device (e.g., X-10) action is desired, but with no accompanying alarm (e.g., front door light).

Type 24
Silent Burglary

This zone type provides an instant alarm, with NO audible indication at any keypad or external sounder, if the zone is faulted when the system is armed in the AWAY, STAY, INSTANT, or MAXIMUM modes. This zone type is usually assigned to all sensors or contacts on exterior doors and windows where bells and/or sirens are NOT desired. A report is sent to the central station. **NOTE:** When the system is disarmed and Chime mode is on, the keypad will beep if the zone is faulted.

Data Field Descriptions

Defaults (where applicable) are Indicated in Text.

The following pages list all data fields in this Control (in numerical order). Use the blank programming form to record the data for this installation. Note that both keypad LEDs flash while in Programming mode.

*20	Installer Code Enter 4 digits, 0–9.	The Installer Code is used to enter the 4-digit Master Security Code. See "Master Code" in the <i>System Operation</i> section for procedure.
*21	Quick Arm Enable 0 = do not allow quick arm 1 = allow quick arm	If enabled, security code is not required to arm the system. The user simply presses and holds down the AWAY or STAY key to arm.
*22	Keypad Backlight Timeout 0 = no timeout; always backlight keys 1 = turn backlighting off after inactivity	This option allows the choice of either always backlighting the keypad or turning the backlighting off after 10 seconds of keypad inactivity.
*23	Forced Bypass 0 = no forced bypass 1 = provide automatic bypass of all open (faulted) zones	All zones bypassed by this function will be displayed after the bypass is initiated. UL installations: must be 0 (no forced bypass)
*24	RF House ID Code 00 = disable all wireless keypad usage 01-31 = House ID	The House ID identifies receivers and wireless keypads. If a 5827 or 5827BD Wireless Keypad or 5804BD Transmitter is to be used, a House ID Code MUST be entered, and the keypad should be set to the same ID.
*25	Powerline Carrier Device (x-10) House ID 0 = A, 1 = B, 2 = C, 3 = D, 4 = E, 5 = F, 6 = G, 7 = H, 8 = I, 9 = J, # + 10 = K, # + 11 = L, # + 12 = M, # + 13 = N, # + 14 = O, # + 15 = P.	Powerline Carrier Devices require a House ID. This field identifies this House ID to the Control. Powerline Carrier Devices are programmed in field * 80.
*26	Chime By Zone 0 = no (chimes on fault of any entry/exit or perimeter zone when Chime mode activated) 1 = yes (chimes on fault of those zones assigned to Zone List 3 when Chime mode on)	This option allows the installer to define the specific zones intended to chime when faulted while the system is in Chime mode. If enabled, these zones are defined in zone list 3 (see <i>*81 Zone List Programming</i> section).
*27	Real Time Clock Display 0 = do not display the time 1 = display the time	Refer to the User's Manual for setting the clock time and date.
*29	Daylight Savings Time Start/End Month 0, 0 = no daylight saving time used. 1-12 = start month and end month	Enter # + 10 for 10, # + 11 for 11, and # + 12 for 12.
*30	Daylight Savings Time Start/End Week 0 = disable 1 = first weekend of month 2 = second weekend 3 = third weekend 4 = fourth weekend 5 = last weekend 6 = next to last 7 = 3 rd from last	Enter the appropriate start and end weekend of the month.
*31	Single Alarm Sounding Per Zone (per armed period) 0 = no limit on alarm sounding per zone 1 = limit alarm sounding to once per arming period for a given zone	UL installations: must be 0 (no limit) This field applies only to burglary zones (zone response types 1-5, 10).
*32	Fire Sounder Timeout 0 = yes, fire sounder timeout after time programmed in field *33 1 = no fire sounder timeout; continue sounding until manually turned off	This Control complies with NFPA requirements for temporal pulse sounding of fire notification appliances. Temporal pulse sounding for a fire alarm consists of the following: 3 pulses – pause – 3 pulses – pause – 3 pulses. . .
*33	Alarm Bell Timeout 0 = No timeout 1 = 4 min 2 = 8 min 3 = 12 min 4 = 16 min	This field determines whether the external sounder will shut off after time allotted, or continue until manually turned off. UL installations: must be set for a minimum of 4 min (option 1)
*34	Exit Delay 00-99 = exit delay time in seconds	The system will wait the time entered before sounding an alarm if the exit door is left open after the system has been armed. UL installations: must be set for a maximum of 60 seconds

*35	Entry Delay 01 00-99 = entry delay time in seconds.	The system will wait the time entered before sounding alarm upon entering if system is not disarmed. UL installations: must be set for a maximum of 45 seconds
*36	Entry Delay 02 00-99 = entry delay time in seconds.	The system will wait the time entered before sounding alarm upon entering. UL installations: must be set for a maximum of 45 seconds
*37	Audible Exit Warning/Quick Exit Exit Warning 0 = no exit warning sound 1 = provide exit warning sound when armed AWAY Quick Exit 0 = no quick exit 1 = allow quick exit	Exit Warning: Sound consists of slow continuous beeps until last 5 seconds, when it changes to fast beeps. The warning sound will end at the termination of exit delay. Quick Exit: If enabled, user can restart the exit delay time after arming in STAY mode by pressing the STAY key. This avoids having the user disarm then re-arm the system after letting someone in or out.
*38	Confirmation of Arming Ding 0 = no ding 1 = confirmation ding after arming system 2 = confirmation ding after arming from RF button or RF keypad only	Confirmation of arming is 1/2 second external sounder "ding" when closing report is sent, or at the end of exit delay (ding occurs when the system receives the RF transmission).
*39	Power Up In Previous State 0 = always power up in a disarmed state 1 = assume the system status prior to power-down	When the system powers up armed, an alarm will occur 1 minute after arming if a zone is faulted. Note that if the previous state was armed AWAY or STAY, the system will not respond to sensor changes for 1 minute, which allows time for sensors such as PIRs to stabilize. UL installations: must be 1 (power up in previous state)

DIALER PROGRAMMING (*40–*50)

Fields *40, *41, *42: Enter up to the number of digits shown. Do not fill unused spaces.

Enter 0–9, # + 11 for '*'; # + 12 for '#'; # + 13 for a pause (2 seconds)

40	PABX Access Code Enter up to 6 digits if PABX is needed to access an outside line.	If fewer than 6 digits need to be entered, exit by pressing []. To clear entries from field, press *40*.
41	Primary Phone No. . Enter up to 20 digits. Enter 0–9; # + 11 for ''; # + 12 for '#'; # + 13 for a pause (2 seconds)	If fewer than 20 digits entered, exit by pressing [*]. To clear entries from field, press *41*. NOTE: Backup reporting (8 attempts are made to the secondary phone number if no kiss-off is received after 8 attempts to the primary number) is automatic only if there is a secondary phone number (field *42).
42	Secondary Phone No. . Enter up to 24 digits. Enter 0–9, # + 11 for ''; # + 12 for '#'; # + 13 for a pause (2 seconds)	If fewer than 24 digits entered, exit by pressing [*]. To clear entries from field, press *42*. See backup reporting note for field *41. If using the paging feature, enter the pager phone number here.

For Fields *43 and *44:

Enter [*] as the fourth digit if a 3-digit account number (for 3+1 dialer reporting format) is used. Enter 0 as the first digit of a 4-digit account number for Nos. 0000–0999. Exit field by pressing [*] if only 3 digits are used.

To clear entries from field, press *43* or *44*.

See blank Programming Form for examples of account number entries.

If using the paging feature, do not enter a leading 0 in the subscriber account number, and do not use digits A-F anywhere in the number. Some paging systems provide voice mail capability, which is activated by a leading 0 in the message.

*43	Primary Subs Account No. . Enter digits 0–9; # +11=B; # +12=C; # +13=D; # +14=E; or # +15=F.	Enter the primary subscriber account number. To clear entries from field, press *43*.
*44	Secondary Subs Account No. . Enter digits 0–9; # +11=B; # +12=C; # +13=D; # +14=E; or # +15=F.	Enter the secondary subscriber account number. To clear entries from field, press *44*.
*47	Phone System Select If central station receiver is not on WATS line: 0 = Pulse Dial; 1 = Tone Dial If central station receiver is on WATS line: 2 = Pulse Dial; 3 = Tone Dial	Enter the type of phone dialing: pulse or tone.

<p>*48</p>	<p>Report Format for Primary/Secondary Primary Secondary See choices below See choices below</p> <p>0 = 3+1; 4+1 ADEMCO Low Speed Standard 1 = 3+1; 4+1 Radionics Standard 2 = 4+2 ADEMCO Low Speed Standard 3 = 4+2 Radionics Standard 6 = 4+2 ADEMCO Express 7 = ADEMCO Contact ID Reporting 8 = 3+1; 4+1 ADEMCO Low Speed Expanded 9 = 3+1; 4+1 Radionics Expanded</p>	<p>Enter * as the 4th digit of *43 through *44, if 3+1 dialer reporting is to be used. For an explanation of these formats, see the System Communication section later in this manual. NOTE: The maximum number of alarm and alarm restore reports during one armed period is determined by field *93.</p>																								
<p>*49</p>	<p>Split/Dual Reporting</p> <table border="1"> <thead> <tr> <th>To Primary</th> <th>To Secondary</th> </tr> </thead> <tbody> <tr> <td>0 = All reports</td> <td>None, unless prim. fails, then all</td> </tr> <tr> <td>1 = Alarms, Restore, Cancel</td> <td>Others</td> </tr> <tr> <td>2 = All except Open/Close, Test</td> <td>Open/Close, Test</td> </tr> <tr> <td>3 = Alarms, Restore, Cancel</td> <td>All</td> </tr> <tr> <td>4 = All except Open/Close, Test</td> <td>All</td> </tr> <tr> <td>5 = All reports</td> <td>All</td> </tr> <tr> <th>To Primary</th> <th>To Paging Number</th> </tr> <tr> <td>6 = All reports except Open/Close</td> <td>Alarms, Open/Close ‡, Troubles</td> </tr> <tr> <td>7 = All reports</td> <td>Alarms, Troubles</td> </tr> <tr> <td>8 = All reports</td> <td>Alarms, Open/Close ‡, Troubles</td> </tr> <tr> <td>9 = All reports except Open/Close</td> <td>Open/Close ‡</td> </tr> </tbody> </table> <p>‡ Will report Users 5-8, and, if using wireless button-type devices, will report the zone number of the arm or disarm button 26-33. All other zones and users are not reported.</p>	To Primary	To Secondary	0 = All reports	None, unless prim. fails, then all	1 = Alarms, Restore, Cancel	Others	2 = All except Open/Close, Test	Open/Close, Test	3 = Alarms, Restore, Cancel	All	4 = All except Open/Close, Test	All	5 = All reports	All	To Primary	To Paging Number	6 = All reports except Open/Close	Alarms, Open/Close ‡, Troubles	7 = All reports	Alarms, Troubles	8 = All reports	Alarms, Open/Close ‡, Troubles	9 = All reports except Open/Close	Open/Close ‡	<p>Use options 0 - 5 when reporting to telephone receivers. Use options 6 - 9 when reporting to a pager is desired. Pager Report Format Options 6-9 send reports to the primary phone number and send reports to a pager, which has its phone number entered as the secondary phone number in field *42. The pager report is a 7-digit code, with optional 16-digit prefix, in the following format: AAAAAAAAAAAAAAAA-EEE-00NN where: AAA = Optional 16 digits for PIN number, etc. See field *88 for full description of these characters. EEE = 3-digit Event Code as follows: 911 = Alarm (NN = zone number) 101 = Open, system disarmed (NN = user no.) 102 = Close, system armed (NN = user no.) 811 = Trouble (NN = zone no.) 00 = Always displayed before 2-digit user/zone no. NN = 2-digit user number or zone number, depending on the type of event (EEE) that occurred. NN=00 indicates AC loss, system low battery, or low battery in 5827/5827BD.</p>
To Primary	To Secondary																									
0 = All reports	None, unless prim. fails, then all																									
1 = Alarms, Restore, Cancel	Others																									
2 = All except Open/Close, Test	Open/Close, Test																									
3 = Alarms, Restore, Cancel	All																									
4 = All except Open/Close, Test	All																									
5 = All reports	All																									
To Primary	To Paging Number																									
6 = All reports except Open/Close	Alarms, Open/Close ‡, Troubles																									
7 = All reports	Alarms, Troubles																									
8 = All reports	Alarms, Open/Close ‡, Troubles																									
9 = All reports except Open/Close	Open/Close ‡																									
<p>*50</p>	<p>15-Second Dialer Delay (Burglary) 0 = no dialer delay 1 = provide 15-second delay of burg. alarm report</p>	<p>If enabled, provides communication delay to the central station, which allows time for the subscriber to avoid a false alarm transmission. This delay does not apply to zone type 6, 7, 8, and 24 alarms, which are always sent as soon as they occur. UL installations: must be 0 (no delay)</p>																								
<p>*51</p>	<p>Periodic Test Report 0 = no test report 2 = weekly 1 = once every 24 hrs 3 = once every 30 days</p>	<p>Test report code entered in field *64 is sent.</p>																								
<p>*52</p>	<p>First test Report Offset 0 = 24 hrs after exit program mode or download 1 = 6 hours after exit program mode or download 2 = 12 hrs after exit program mode or download 3 = 18 hrs after exit program mode or download</p>	<p>This is the time to first report from programming or downloading.</p>																								
<p>*53</p>	<p>Sescoa/Radionics Select 0 = Radionics (0-9, B-F reporting) 1 = SESCOA (0-9 only reporting)</p>	<p>Select 0 for all other formats.</p>																								
<p>*58</p>	<p>RFJam Detection 0 = no jam detection 1 = RF jam detection on with event logging, but no cs report 2 = RF jam detect on with event logging and with cs report (if trouble/restore report is enabled in fields *60, *71)</p>	<p>If the control detects an RF jam condition, a "FAULT" message appears for zone 90. The Contact ID code for RF Jam is 344.</p>																								

TO PROGRAM SYSTEM STATUS AND RESTORE REPORT CODES (* 59 – * 76, & * 89)

Program Report Codes using the interactive *56 Zone Programming Mode, or codes can be entered in data fields *59-*76, *89. The following is a set of guidelines when programming report codes. The actual report code digits that you enter depend upon the particular installation, and should be in agreement with you and the central station office receiving the signals.

With a 3+1 or 4+1 Standard Format: Enter a code in the first box: 1–9, A, B, C, D, E, or F. Enter "#+10" for A (reports a "0" on some receivers), "#+11" for B, "#+12" for C, "#+13" for D, "#+14" for E, "#+15" for F.

An entry of "0" in the *first* box will disable a report. An entry of "0" in the second box results in automatic advance to the next field.

With an Expanded or 4+2 Format: Enter codes in *both* boxes (1st and 2nd digits) for 1–9, or A–F, as described above. An entry of "0" in the first box will disable a report. An entry of "0" in the second box will eliminate the expanded message for that report.

With ADEMCO Contact ID Reporting: Enter a digit in the first box to enable the zone to report. Use a different digit for each zone until you have used up available digits. If the number of zones exceeds the number of available digits, begin with digit 1 again. This is an "enabling" code only and is not the actual code sent to the central station office. Entries in the second boxes will be ignored. For system status (non-alarm) codes, enter a "1" in the first box for all the system conditions you want to send to the central station. A "0" in the first box disables the report.

SYSTEM STATUS REPORT CODES (*59–*68)

*59	Exit Error Report Code See notes above	If the system is armed and an entry/exit or interior zone is still open after the exit delay time has expired, an alarm will sound at the keypad and external sounder. If the system is disarmed before the end of the entry delay that immediately follows, the alarm sounding will stop and no message will be sent to the central station. The keypad will display "CA (CANCELED ALARM)." If the system is not disarmed before the end of the entry delay mentioned above, and an entry/exit or interior zone is still open, an "exit alarm" message will be sent to the central station if an Exit Error report code is selected in this field. The keypad will display "EA (EXIT ALARM)," and the alarm sounding will continue until the system is disarmed (or timeout occurs). An Exit Alarm condition will also result if a fault occurs in an exit or interior zone within 2 minutes following the end of the exit delay, and an "Exit Alarm" message will be sent to the central station. If Contact ID format has been programmed, the message will contain the zone number and error code 374 (Trouble–Exit Error). If 4+2 format is used, the digit entered in this field will be sent followed by the second digit of the programmed alarm code for that zone. If 3+1 or 4+1 format is used, only the digit entered in this field will be sent. This message will go to the primary phone no. Under any of these conditions, no restore message will be sent. If "0" is entered in this field, no special message will be sent, only the regular alarm and alarm restore code for the zone.
*60	Trouble Report Code See notes above	This will be sent if a zone goes into trouble.
*61	Bypass Report Code See notes above	This will be sent when a zone is manually bypassed.
*62	AC Loss Report Code See notes above	Timing of this report is random with up to a 4-hour delay. If AC restores before the report goes out, there is no AC restore report.
*63	Low Battery Report Code See notes above	This will be sent when a low battery condition exists in the system's standby battery.
*64	Test Report Code See notes on previous page	This is sent periodically to test that the communicator and phone lines are operational (frequency of report is selected in field *51).
*65	Open Report Code See notes on previous page	This is sent upon disarming of the system. 2nd digit = user number, if expanded or 4+2 reporting is selected.
*66	Arm AWAY/STAY Report Code See notes on previous page	This option allows for independent programming of AWAY and STAY reports. 2nd digit of report is user number if expanded or 4+2 reporting is selected. NOTE: OPEN reports are not sent if the associated closing report is not enabled.
*67	RF transmitter Low Batt. Report Code See notes on previous page	This is sent in the event that a wireless transmitter low battery condition exists.
*68	Cancel Report Code See notes on previous page	This is sent upon disarming of the system after an alarm condition was reported.

RESTORE REPORT CODES (*70– 76)

*70	Alarm Restore Report Code, 1st Digit See notes on previous page	This is sent when the zone that caused an alarm is restored to its nonfaulted condition. 2nd digit is automatically sent as the 2nd digit of the zone alarm report code programmed in field *56, if expanded or 4+2 reporting is selected.
*71	Trouble Restore Report Code See notes on previous page	This is sent when a trouble in a zone is restored.
*72	Bypass Restore Report Code See notes on previous page	This is sent when a zone that has been bypassed is unbypassed.
*73	AC Restore Report Code See notes on previous page	This is sent when AC power has been restored after an AC power outage.
*74	Low Battery Restore Report Code See notes on previous page	This is sent when a system low battery condition is restored to normal.
*75	RF Transmitter Low Batt. Restore Code See notes on previous page	This is sent when a transmitter that previously sent in a “low battery” message has sent a message indicating it no longer has a low battery condition.
*76	Test Restore Report Code See notes on previous page	This is sent when the test mode is exited. A restore code entered here will cause a restore message to be sent when Test mode is exited.
*87	AUX Function/1-Button Paging 0 = Aux key performs defined function (macro) 1 = Aux key sends predefined message to pager	If 0, user can define a macro function for the AUX key. See user manual for description of the use of this key. If 1, you must also select an option 6-9 in field *49. The actual pager message is 999-9999. Note that the hyphen may not be displayed, depending on the pager service.
88	Pager Characters Enter up to 16 digits that will appear in front of the 7-digit pager message. To enter “” = [#] + [11] To enter “#” = [#] + [12] To enter 2-second pause = [#] + [13] NOTES: Verify that the pager supports [*] and [#] characters before using them. Some pagers require an additional delay [pause] in order to receive the entire message.	If entered, these digits will appear in front of the 7-digit pager message sent by the control (either upon a system event or upon pressing the AUX key [if programmed for paging]). These digits can consist of a PIN number, account number, pauses or special digits needed by the pager (these types of characters are not displayed), or any other characters the user chooses that will be displayed (eg., using a character code to distinguish between control panel messages and other pager messages). You do not need to fill all 16 digits. Press [*] + next field number to exit the field. To clear the field, press *88*. See field *87 to select the AUX key Paging feature. See field *49, which must have an option 6-9 selected to enable paging messages, for description of the pager message.
*89	Event Log 80% Full Report Code See notes on previous page	If an Event Logging selection is made in field *90, a message can be sent to the central station receiver when the log is 80% full. If the log becomes full, a new message will overwrite the oldest message in the log. NOTE: Aside from the selection made by the installer in field *90, all control and readout from the log is accomplished via the downloader.
*90	Event Logging Options 0 = No event logging 1 = log Alarm/Alarm Restore 2 = log Trouble/Trouble Restore 4 = log Bypass/Bypass Restore 8 = log Open/Close x = log combination of events (add value of entries)	Example: To select “Alarm/Alarm Restore” and “Open/Close,” enter 9 (1 + 8); to select all events, enter #15. The default of “3” = alarm/alarm restore (1) plus trouble/trouble restore (2). The system has the ability to record various events in a history log (84-event capacity) that can be recalled via the V-LINK software. The types of events to be logged can be selected as indicated. At any time, the downloader operator can then upload the log and view or print out all or selected categories of the log. The log can also be cleared by the download operator. The display/printout at the central station will show the date, time, event, and description of the occurrences. The time is calculated by an internal clock at the central station computer. Note that the time for any events that occur prior to a system power-down or an entry into the Programming mode cannot be calculated by the central station computer. The time will then appear on the log as “unknown.” NOTE: System messages are logged when any non-zero selection is made.

*91	Future Use (option selection) 0 = must be zero	This is a future option and must be set to 0. If this option is inadvertently enabled, the Contact ID event code 606 may be sent to the central station after an alarm report.
*92	Number of Reports In Armed Period 0 = reports limited to a total of 10 1 = unlimited number of reports	This option can be used to limit the number of messages (alarm & alarm restore reports) sent to the central station in an armed period. UL installations: must be 1 (unlimited reports)
*93	Flexible Callback 0 = no flexible callback 2 = last 2 digits flexible 1 = last digit flexible 3 = last 3 digits flexible	If enabled, the control will ignore the last 1, 2, or 3 digits of the programmed callback number (field *94) during a single download session. This allows the download operator to temporarily change the callback phone number by the number of digits selected, which allows the control to call back similar, but different numbers during a single session. For example, if downloading to a large number of controls, the operator can command the controls to call back phone numbers 555-1111, 555-1112, 555-1113, etc., thus spreading the communications among several computers.
DOWNLOAD INFORMATION (*94, *95)		
94	Download Call Back Phone Number Enter up to 20 digits as follows: 0-9, # +11 for "", # + 12 for "#", # + 13 for a pause.	This is the phone number the control will use to call back the downloading computer. Do not fill unused spaces. End field by pressing *. To clear entries from field, press *94*.
*95	Ring Detection Count For Downloading 0-15 = number of rings before control picks up phone line (15 = bypass answering machine)	

Other Programming Commands

- *56 ZONE PROGRAMMING MODE**
Interactive menu mode used for programming zone attributes and report codes. Refer to the **56 Zone Programming Mode* section for procedure.
- *80 POWERLINE CARRIER DEVICE PROGRAMMING**
Interactive menu mode for programming Powerline Carrier Devices. Refer to the **80 Device Programming Menu Mode* section for detailed procedure.
- *81 ZONE LISTS FOR OUTPUT DEVICES**
Interactive menu mode for programming zone lists for Powerline Carrier Devices. Refer to the **81 Zone List Menu Mode* section for detailed procedure.
- *83 SEQUENTIAL MODE**
Interactive menu mode used to enter RF transmitter serial numbers. Refer to the **83 Sequential Mode* section for detailed procedure.
- *84 ASSIGN ZONE VOICE DESCRIPTORS**
Interactive menu mode used to assign descriptors to each zone. These descriptors will be announced whenever the system announces an event involving a zone.
- *85 RECORD CUSTOM VOICE DESCRIPTORS**
Interactive menu mode used to record custom descriptors for use with each zone.
- *96 INITIALIZE DOWNLOAD ID AND SUBSCRIBER ACCT. NO. FOR DOWNLOADING**
Pressing *96 initializes the system for downloading.
- *97 SET ALL PROGRAM FIELDS TO 1 OF 5 SETS OF DEFAULT VALUES**
See Default Tables at the end of this manual.
- *98 EXITS PROGRAMMING MODE**
Prevents re-entry by : Installer Code + 8 + 0 + 0; allows re-entry only by Power-up, then [*] and [#].
- *99 EXITS PROGRAMMING MODE**
Allows re-entry to program mode by: Installer Code + 8 + 0 + 0; or by Power-up, then [*] and [#].

**56 Zone Programming Mode*

This is an interactive menu mode that is used to program zone numbers, zone types, alarm and report codes, and to identify the type of loop input device. This mode can also be used for entering 5800 Series transmitter serial numbers.

NOTE: There are two methods for entering transmitter serial numbers. The first method is by using *56 Zone Programming mode (described below). The second method is by using *83 Sequential mode. Note that the *83 Sequential mode requires that all zone information first be entered using *56 Zone Programming mode.

You must refer to these instructions or to the Program Form while programming the system because the keypad display does not show prompt titles. Instead, prompts are indicated by a number/letter combination.

The prompts for *56 are as follows:

- Zone Number ----- for entering the zone number
- Zone Type ----- for entering zone type
- Report Code----- for entering the zone's report code
- Input Type ----- for entering the transmitter's input type
- Loop Number ----- for entering the transmitter loop number
- Delete Serial Number? ----- for deleting existing serial number
- Enroll Mode? ----- selects serial number enroll mode
- Serial Number----- for entering transmitter's serial number
- Voice Descriptor?----- selects voice descriptor mode
- Descriptor 1 ----- for entering first descriptor word
- Descriptor 2 ----- for entering second descriptor word
- Descriptor 3 ----- for entering third descriptor word

While in Program mode, press *56 to enter Zone Programming Menu Mode.

Refer to the zone assignment table for *56 on the separate programming form.

The following explains the *56 prompts in detail. The left two columns identify the prompts and list the available entries for each. The right-most column provides a further explanation of the entries.

NOTE: Entry of a number other than one specified will give unpredictable results.

<div style="border: 1px solid black; padding: 5px; display: inline-block;">A 01</div>	<p>Zone number 01-41, 95, 96, 99 = Zone number [*] = continue 00 = exit Zone Programming mode</p>	<p>Enter the 2-digit zone number to be programmed, then press [*] to advance.</p> <ul style="list-style-type: none"> • Zone 1 = hardwire • Zones 2-25 = RF zones • Zones 26-41 = Button zones • Zones 95, 96, 99 = Panic zones <p>Pressing 00 exits mode, upon which the prompt “56” blinks, indicating the mode is inactive. Press [*] + any field number to go to that field.</p>																
<div style="border: 1px solid black; padding: 5px; display: inline-block;">b zt</div>	<p>Zone type 00-24 = zone type [*] = continue [#] = return to previous prompt</p>	<p>Each zone must be assigned to a zone type, which defines the way in which the system responds to faults in that zone. Enter the 2-digit zone type for this zone as follows:</p> <table style="width: 100%; border: none;"> <tr> <td>00 = Not Used</td> <td>08 = 24 Hr Aux</td> </tr> <tr> <td>01 = Entry/Exit #1</td> <td>09 = Fire w/verify</td> </tr> <tr> <td>02 = Entry/Exit #2</td> <td>10 = Interior w/Delay</td> </tr> <tr> <td>03 = Perimeter</td> <td>20 = Arm-Stay</td> </tr> <tr> <td>04 = Interior Follower</td> <td>21 = Arm-Away</td> </tr> <tr> <td>05 = Trouble Day/Alarm Night</td> <td>22 = Disarm</td> </tr> <tr> <td>06 = 24 Hr Silent</td> <td>23 = No Alarm Response</td> </tr> <tr> <td>07 = 24 Hr Audible</td> <td>24 = Silent Burglary</td> </tr> </table>	00 = Not Used	08 = 24 Hr Aux	01 = Entry/Exit #1	09 = Fire w/verify	02 = Entry/Exit #2	10 = Interior w/Delay	03 = Perimeter	20 = Arm-Stay	04 = Interior Follower	21 = Arm-Away	05 = Trouble Day/Alarm Night	22 = Disarm	06 = 24 Hr Silent	23 = No Alarm Response	07 = 24 Hr Audible	24 = Silent Burglary
00 = Not Used	08 = 24 Hr Aux																	
01 = Entry/Exit #1	09 = Fire w/verify																	
02 = Entry/Exit #2	10 = Interior w/Delay																	
03 = Perimeter	20 = Arm-Stay																	
04 = Interior Follower	21 = Arm-Away																	
05 = Trouble Day/Alarm Night	22 = Disarm																	
06 = 24 Hr Silent	23 = No Alarm Response																	
07 = 24 Hr Audible	24 = Silent Burglary																	
<div style="border: 1px solid black; padding: 5px; display: inline-block;">C rc</div>	<p>Report code Enter the report code for this zone. [*] = continue [#] = return to previous prompt</p>	<p>The report code consists of 2 hexadecimal digits, each in turn consisting of 2 numerical digits. For example, for a report code of “3C”, enter [0][3] for “3” and [1][2] for “C”. If this is Zone 1, the system skips to the VOICE DESCRIPTOR prompt (1C).</p>																
<div style="border: 1px solid black; padding: 5px; display: inline-block;">d i</div>	<p>Input type 3 = RF (supervised RF) – sends periodic check-in signals, faults, restore and low battery signals† 4 = UR (unsupervised RF) – sends same as “RF” type, but control does not supervise the check-in signals†† 5 = BR (button type) – sends only fault and low battery signals; does not send restores; does not send check-in†† [*] = continue [#] = return to previous prompt</p>	<p>Enter the input type for the transmitter assigned to this zone. Refer to the transmitter’s instructions for input types of each transmitter.</p> <p>† transmitter must remain within range of receiver, otherwise a supervision failure signal will occur</p> <p>†† transmitter may be carried off premises (out of range) without causing supervision failure</p>																
<div style="border: 1px solid black; padding: 5px; display: inline-block;">E 1 L</div>	<p>Loop number 1-4 = loop number for the zone of the transmitter being entered. 0 + [*] = continue to DELETE SERIAL NUMBER prompt (F) [*] = continue to the ENROLL MODE prompt (1A) if not entered, or VOICE DESCRIPTOR prompt if already entered [#] = return to previous prompt</p>	<p>The default is loop 1. If a different loop number is being used on this transmitter, enter the desired loop number and press [*] to continue (see the transmitter's Installation Instructions for specific loop designations).</p> <p>If “L” is displayed, the serial number for this transmitter has already been entered. You can keep the serial number and skip to the VOICE DESCRIPTOR prompt, or you can continue to the DELETE SERIAL NUMBER prompt.</p>																
<div style="border: 1px solid black; padding: 5px; display: inline-block;">F</div>	<p>Delete serial number/zone parameters 0 = keep existing number and proceed to VOICE DESCRIPTOR prompt 1 = delete the serial number only for RF zones 2 = delete serial number and all other zone information</p>	<p>This function deletes either the serial number only or the serial number and all other zone information programmed for RF zones. If “1,” the system will delete the serial number of this RF zone and return to the ZONE NUMBER prompt (A). If “2,” the system will delete the serial number and all other zone information programmed for this RF zone. For non-RF zones, entry of 1 or 2 will delete all zone information.</p>																

<div style="border: 1px solid black; padding: 5px; width: fit-content; margin: 10px auto;">1A</div>	<p>Enroll mode 0 = skip to the VOICE DESCRIPTOR prompt (1C); if zone type is "00," skip to DELETE SERIAL NUMBER prompt 1 = enter now and proceed to SERIAL NUMBER prompt (1b)</p>	<p>If the transmitter's serial number has not been previously entered, you may enter the enroll mode now by entering "1." Enter "0" if you wish to enter the transmitter later, using the *83 Sequential Mode described in the *83 <i>Sequential Mode</i> section later in this manual.</p>
<div style="border: 1px solid black; padding: 5px; width: fit-content; margin: 10px auto;">1b</div>	<p>Serial number Enter the transmitter's 7-digit serial number. [*] = continue to prompt 1C, unless zone type is 00, which will return system to DELETE SERIAL NUMBER prompt (F) [#] = return to previous prompt</p>	<p>Manually enter the 7-digit serial number printed on the transmitter. If you enter an incorrect digit, press the [#] key to backup to that digit and reenter the correct digit.</p> <p>When all 7 digits are entered, press the [*] key. Each digit will be re-displayed, and the keypad will beep once for digits 1-6, 3 times for the last digit. If less than 7 digits are entered, the un-entered digits will display "F." If too many digits have been entered, the first 6 digits will be saved, along with the last digit that was entered (entering 123456789 yields serial number 1234569).</p> <p>If the serial number is correct, press [*] again to save it and advance to the next prompt. If no entry is made for 30 seconds, the system returns to prompt 1A.</p> <p>If the serial number is not correct, press [#], which deletes the number and returns to the ENROLL MODE prompt (1A), allowing you to reenter the number.</p> <p>If the serial and loop number combination is already present in the system, the keypad will emit a single long beep.</p>
<div style="border: 1px solid black; padding: 5px; width: fit-content; margin: 10px auto;">1C</div>	<p>Voice descriptor 0 = skip to next zone (A) 1 = enter descriptor mode; existing descriptor for this zone will be announced</p>	<p>Each zone can have a voice descriptor of up to 3 words that will be announced whenever the system announces status for that zone.</p>
<div style="border: 1px solid black; padding: 5px; width: fit-content; margin: 10px auto;">1d vv</div>	<p>Descriptor 1 Enter [#] + 2-digit vocabulary index number† of first descriptor word for this zone. 6 = accept word and advance to descriptor 2 (descriptor 2 will be announced) 8 = accept word and advance to next zone (prompt A) – entire zone descriptor will be announced Press any other key to repeat the selected word.</p>	<p>† see *84 <i>Assign Zone Voice Descriptors</i> section for vocabulary index</p> <p>Use the [6] or [8] key to advance as described. To change the entered index number before pressing [6] or [8], simply press [#] + desired 2-digit vocabulary index number. If descriptor 1 is not desired, enter [#] + 99 (blank), then press [8] to return to zone number prompt.</p>
<div style="border: 1px solid black; padding: 5px; width: fit-content; margin: 10px auto;">1E</div>	<p>Descriptor 2 Enter [#] + 2-digit vocabulary index number† of second descriptor word for this zone. 6 = accept word and advance to descriptor 3 (descriptor 3 will be announced) 8 = accept word and advance to next zone (prompt A) – entire zone descriptor will be announced Press any other key to repeat the selected word.</p>	<p>† see *84 <i>Assign Zone Voice Descriptors</i> section for vocabulary index</p> <p>Use the [6] or [8] key to advance as described. To change the entered index number before pressing [6] or [8], simply press [#] + desired 2-digit vocabulary index number. If descriptor 2 is not desired, enter [#] + 99 (blank), then press [8] to return to zone number prompt.</p>
<div style="border: 1px solid black; padding: 5px; width: fit-content; margin: 10px auto;">1F</div>	<p>Descriptor 3 Enter [#] + 2-digit vocabulary index number† of third descriptor word for this zone. 6 or 8 = accept word and advance to next zone (prompt A) – entire zone descriptor will be announced Press any other key to repeat the selected word.</p>	<p>† see *84 <i>Assign Zone Voice Descriptors</i> section for vocabulary index</p> <p>Use the [6] or [8] key to advance as described. To change the entered index number before pressing [6] or [8], simply press [#] + desired 2-digit vocabulary index number. If descriptor 3 is not desired, enter [#] + 99 (blank), then press [8] to return to zone number prompt.</p>

**80 Device Programming Menu Mode*

Powerline Carrier devices (eg., X-10 brand devices) are programmable switches that can be used to perform many different functions. They can be used to turn lights on and off, control sounders, or for status indications. In this system, each device must be programmed as to how to act (ACTION), when to activate (START), and when to deactivate (STOP). Each of these is described below.

The control supports a total of 8 output devices.



When using Powerline Carrier Devices, you must also use a PL513 Powerline Interface Module in addition to the supplied transformer.

The PL513 Powerline Interface Module supplies signals from the control panel through the premises AC wiring to the Powerline Carrier Devices (which are plugged into AC outlets). Devices plugged into Powerline Carrier Devices can then be made to perform various functions in response to commands entered at the keypads in the security system.



Powerline Carrier Devices and the PL513 Powerline Interface Module are not UL Listed for fire or burglary functions and are intended for home automation.

Programming Options Defined

The following will help you understand the programming of output devices when using *80 and *81 modes.

ACTION The "ACTION" of the device is how the device will respond when it is activated by the "START" programming. There are four different choices of actions:

- ACTIVATE for 2 SECONDS and then reset.
- ACTIVATE and REMAIN ACTIVATED until stopped by some other event.
- PULSE ON and OFF until stopped by some other event.
- NOT USED when the device is not used.

START The "START" programming determines when and under what conditions the device will be activated. The following START options are available:

Start by Event

1. Event is the condition (alarm, fault, trouble) that must occur to a zone or group of zones (zone list) in order to activate the device. These conditions apply **only** when a zone list is used. The different choices for "EVENT" are listed below and in the "Programming Powerline Carrier Devices" paragraph that follows.

- ALARM Device activates upon any alarm in an assigned zone in the zone list.
- FAULT Device activates upon any opening or short in an assigned zone in the zone list.
- TROUBLE Device activates upon any trouble condition in an assigned zone in the zone list.
- NOT USED Device action is not dependent upon one of the above events.

2. A zone list is a group of zones to which the "EVENT" applies in order to activate a particular device. Note that there are a total of 3 output device-related zone lists that can be programmed in *81 menu mode; when the selected EVENT (alarm, fault or trouble) occurs in **any** zone in the selected "Start" ZONE LIST (1, 2, or 3), activation of the selected device will START.

Start by Zone Type or System Operation

If a system operation, such as "DISARMING" or "ANY FIRE ALARM," is to activate the device, the appropriate choice would also be entered under the "ZONE TYPE" option. "ZONE TYPE" is used independently of the "EVENT/ZONE LIST" combination.

If a "ZONE TYPE" is chosen, any zone of that response type going into alarm, trouble, or fault will cause the device to activate as selected in "ACTION." If the same "ZONE TYPE" is also chosen for the STOP programming, any zone of that type that restores will de-activate the device.

If a "SYSTEM OPERATION" is chosen (e.g., End of Exit Time), that operation will cause the device to activate as selected in "ACTION." The different choices for "ZONE TYPE" and "SYSTEM OPERATION" are listed in the "Start zone type" paragraphs later in this section, and in the Programming Form.

STOP

The "STOP" programming determines when and under what conditions the device will be de-activated. The following options are available:

Upon Restore of a Zone List

Restore Zone List: If a "ZONE LIST" is used as the "Stop" event, the device will de-activate when **all** the zones in that list restore from a previous fault, trouble, or alarm condition. This will occur regardless of what is programmed to "START" the device; therefore, a "RESTORE ZONE LIST" would normally only be used when a "ZONE LIST" is used to start the device.

Upon a Zone Type or System Operation

Zone Type/System Operation: Instead of using a "RESTORE ZONE LIST," a specific zone (response) type or system operation action can be selected to de-activate the device.

If a specific "ZONE TYPE" is chosen, any zone of that response type that restores from a previous alarm, trouble, or fault condition will cause the device to de-activate.

If a "SYSTEM OPERATION" is chosen, that operation will cause the device to de-activate.

During normal system operation, any devices may be manually started by keypad entry of: **Code* + # + 4 + "n;"** or manually stopped by keypad entry of: **Code* + # + 7 + "n,"** where "n" = the device number to be controlled.

* Code is required for devices 7 and 8. For devices 1-6, code is not required. See User Manual for more information.

Programming Powerline Carrier Devices

While in program mode, press *80 to enter Output Device Menu Mode. This mode is used to program all output devices used in the system. Refer to the output device table for *80 on the separate programming form when programming output devices.

NOTE: The House ID of the Powerline Carrier Devices must be entered in data field *25.

The prompts for *80 are as follows:

<input type="text" value="80"/>	Powerline Carrier Device Programming Main Menu prompt
<input type="text" value="A 01"/>	Device Number ----- for entering the device number
<input type="text" value="b"/>	Device Action----- for defining the action the device will perform when active
<input type="text" value="C"/>	Start Event Type----- for assigning the event type to start the action
<input type="text" value="d"/>	Start Zone List ----- for assigning the zone list to start the action
<input type="text" value="E"/>	Start Zone Type----- for assigning the zone type to start the action
<input type="text" value="F"/>	Stop Zone List ----- for assigning the zone list to stop the action
<input type="text" value="1A"/>	Stop Zone Type----- for assigning the zone type to stop the action

The following explains these prompts in detail. The left two columns identify the prompts and list the available entries. The right-most column provides a further explanation of the entries.

NOTE: Entry of a number other than one specified will give unpredictable results.

<div style="border: 1px solid black; padding: 5px; display: inline-block;">80</div>	<p>Powerline Carrier Device programming 0 = exit mode 1 = enter mode</p>	<p>Pressing 1 advances to the next prompt below. Pressing 0 exits mode, upon which this prompt blinks, indicating the mode is inactive. Press [*] + any field number to go to that field.</p>																														
<div style="border: 1px solid black; padding: 5px; display: inline-block;">A 01</div>	<p>Device number 01-08 = device number to be programmed [*] = continue 00 = exit Device Programming mode</p>	<p>Enter device numbers as 2-digit entries.</p>																														
<div style="border: 1px solid black; padding: 5px; display: inline-block;">b aa</div>	<p>Device action 0 = No response 1 = Close for 2 seconds 2 = Close and Stay Closed 3 = Continuous Pulse on & off (1 sec ON, 1 sec OFF) [*] = continue [#] = return to previous prompt</p>	<p>Enter the 1-digit action (0-3) for the device being programmed (current action is displayed). NOTES: 1. If action 3 is selected (pulse), only up to 3 different devices can be pulsed if one of the devices is a siren/horn (X-10 Powerhouse Security model SH10A). In addition, the siren/horn cannot be manually activated using the lights on/lights off keypad commands. 2. If using an X-10 Powerhouse Security SH10A siren: • you must use device action “3.” • you must change the device action default to “3” if using default table 2 or 4</p>																														
<div style="border: 1px solid black; padding: 5px; display: inline-block;">[et</div>	<p>Start event type 0 = Not used 1 = Alarm 2 = Fault 3 = Trouble [*] = continue [#] = return to previous prompt</p>	<p>Enter the 1-digit event type (0-3) to activate the device being programmed. A zone list must be used in conjunction with an event. If a zone type/system operation is to be used instead of an event, enter 0.</p>																														
<div style="border: 1px solid black; padding: 5px; display: inline-block;">d zl</div>	<p>Start zone list 1-3 = zone list number (to be programmed in field *81) 0 = zone list not used for this device [*] = continue [#] = return to previous prompt</p>	<p>If a zone list will be used to start the device action, enter the zone list number at this prompt.</p>																														
<div style="border: 1px solid black; padding: 5px; display: inline-block;">E zt</div>	<p>Start zone type 01-58 = zone type to start this device action (select only those that are applicable) 00 = zone type not used for this device [*] = continue [#] = return to previous prompt</p>	<p>If a zone type or system operation will be used to start the device action, enter the appropriate 2-digit code for the device being programmed (see table that follows).</p> <p style="text-align: center;">Choices for zone types</p> <table style="width: 100%; border: none;"> <tr> <td>00 = Not Used</td> <td>04 = Interior Follower</td> <td>08 = 24 Hr Aux</td> </tr> <tr> <td>01 = Entry/Exit #1</td> <td>05 = Trouble Day/Alarm Night</td> <td>09 = Fire</td> </tr> <tr> <td>02 = Entry/Exit #2</td> <td>06 = 24 Hr Silent</td> <td>10 = Interior w/Delay</td> </tr> <tr> <td>03 = Perimeter</td> <td>07 = 24 Hr Audible</td> <td>24 = Silent Burglary</td> </tr> </table> <p style="text-align: center;">Choices for system operation</p> <table style="width: 100%; border: none;"> <tr> <td>20 = Arming–Stay</td> <td>36 = At Bell Timeout**</td> <td>42 = System Battery Low</td> </tr> <tr> <td>21 = Arming–Away</td> <td>38 = Chime</td> <td>43 = Communication Failure</td> </tr> <tr> <td>22 = Disarming (Code + OFF)</td> <td>39 = Any Fire Alarm</td> <td>52 = KISSOFF</td> </tr> <tr> <td>31 = End of Exit Time</td> <td>40 = Bypassing</td> <td>58 = Duress</td> </tr> <tr> <td>32 = Start of Entry Time</td> <td></td> <td></td> </tr> <tr> <td>33 = Any Burglary Alarm</td> <td></td> <td></td> </tr> </table> <p>** Or at Disarming, whichever occurs earlier</p>	00 = Not Used	04 = Interior Follower	08 = 24 Hr Aux	01 = Entry/Exit #1	05 = Trouble Day/Alarm Night	09 = Fire	02 = Entry/Exit #2	06 = 24 Hr Silent	10 = Interior w/Delay	03 = Perimeter	07 = 24 Hr Audible	24 = Silent Burglary	20 = Arming–Stay	36 = At Bell Timeout**	42 = System Battery Low	21 = Arming–Away	38 = Chime	43 = Communication Failure	22 = Disarming (Code + OFF)	39 = Any Fire Alarm	52 = KISSOFF	31 = End of Exit Time	40 = Bypassing	58 = Duress	32 = Start of Entry Time			33 = Any Burglary Alarm		
00 = Not Used	04 = Interior Follower	08 = 24 Hr Aux																														
01 = Entry/Exit #1	05 = Trouble Day/Alarm Night	09 = Fire																														
02 = Entry/Exit #2	06 = 24 Hr Silent	10 = Interior w/Delay																														
03 = Perimeter	07 = 24 Hr Audible	24 = Silent Burglary																														
20 = Arming–Stay	36 = At Bell Timeout**	42 = System Battery Low																														
21 = Arming–Away	38 = Chime	43 = Communication Failure																														
22 = Disarming (Code + OFF)	39 = Any Fire Alarm	52 = KISSOFF																														
31 = End of Exit Time	40 = Bypassing	58 = Duress																														
32 = Start of Entry Time																																
33 = Any Burglary Alarm																																
<div style="border: 1px solid black; padding: 5px; display: inline-block;">F zl</div>	<p>Stop zone list 1-3 = zone list to stop this device action 0 = zone list not used [*] = continue [#] = return to previous prompt</p>	<p>If a zone list will be used to STOP, or restore, the device action, enter the zone list number 1, 2, or 3 (to be programmed in *81 mode). If not used, enter 0.</p>																														
<div style="border: 1px solid black; padding: 5px; display: inline-block;">IA zt</div>	<p>Stop zone type 01-58 = zone type to start this device action (select only those that are applicable) 00 = zone type not used for this device [*] = continue [#] = return to previous prompt</p>	<p>If a zone type or system operation will be used to STOP the device action, enter the appropriate 2-digit code (see the "ZT" choices listed above). If not, enter 00. The display then returns to the DEVICE NUMBER prompt (A) so that you can enter the next device number to be programmed, or enter [0][0] to end device programming.</p>																														

*81 Zone List Menu Mode

While in Program mode, press *81 to enter Zone List Menu Mode. This mode is used to program zone lists for output devices (programmed in *80 menu mode) or Chime-by-Zone in Zone List 3.

NOTES:

- Any list may include any or all of the system's zone numbers.
- A zone list can be assigned to more than one Powerline Carrier Device.

The prompts for *81 are as follows:

81	Zone List Programming ----- Main Menu prompt
A 01	Zone List Number ----- for entering the zone list number to be programmed
b	Zone Entry to List ----- for entering zones to the assigned zone list
C	Delete Entire List? ----- for deleting the entire zone list and its contents
d	Delete Specific Zones From List? -- Selects whether to delete zones or return to next zone list number
E	Delete Zones ----- for deleting specific zones from the current zone list

The following explains these prompts in detail. The left two columns identify the prompts and list the available entries. The right-most column provides a further explanation of the entries.

NOTES:

1. Entry of a number other than one specified will give unpredictable results.
2. Do not assign zones with zone types 20, 21 or 22 to a zone list.

81	Zone list programming 0 = exit mode 1 = enter mode	Pressing 1 advances to the next prompt below. Pressing 0 exits mode, upon which this prompt blinks, indicating the mode is inactive. Press [*] + any field number to go to that field.
A 01	Zone list number 01-03 = zone list number to be programmed 00 = exit Zone List mode [*] = continue	Enter the Zone List Number 01, 02, or 03 to program (or 00 if no zone lists are used).
b <i>zz</i>	Zone entry to list 01-41, 95, 96, 99 = zone numbers to add to zone list [*] = accept zone number and enter the next zone number 00 = accept zone number(s) and continue to next prompt	Enter each zone number to add to the zone list by first entering the zone number, then the [*] key (for example, 01* 02* 03*). After all zones desired are entered, press 00 to advance.
C	Delete entire zone list? 0 = don't delete; continue to next prompt 1 = delete the current zone list	To delete the zone list, enter 1. All zones in the zone list will be deleted automatically and programming will return to the ZONE LIST NUMBER prompt. To save the zone list or delete specific zones from the list, enter 0.
d	Delete zones from list? 1 = continue to delete zones prompt 0 = don't delete; continue to next zone list number (prompt A....01) [#] = return to previous prompt	To save the entire zone list, enter 0 and programming will return to the ZONE LIST NUMBER prompt. To delete a zone or zones in a zone list enter 1.
E	Delete zones Enter each 2-digit zone number to be deleted from the current zone list, followed by the [*] key. [*] = delete zone and enter next zone to be deleted 00 = delete zone and return to next zone list number (prompt A....01) desired.	After all zones to be deleted are entered, enter 00 to return to the ZONE LIST NUMBER prompt so that another list can be programmed, if desired.

*83 Sequential Mode

By using this mode, you can add the serial number of a transmitter in a zone, but retain all other existing data that has been programmed for that zone. Note that the *83 Sequential mode requires that all zone information must first be entered using the *56 Zone Programming mode

Certain button-type transmitters have more than one button (e.g., 5801). Note that each button must be assigned to a different zone. Similarly, the 5816 Transmitter has contact terminals *and* a reed switch for use with a magnet. If using both, each must also be assigned to a different zone.

This means that the procedures that follow must be repeated for each button or contact on the transmitter.

NOTE: Use this mode only after all other zone information has been programmed, including transmitter loop numbers.

Enter Serial Number Sequential mode by pressing *83. The prompts for *83 are as follows:

- A 01 Zone Number ----- for entering the zone number to be programmed
- b Enroll Zone? ----- Selects whether to enter zone displayed or select another zone
- C Enroll Serial Number ----- for entering transmitter serial numbers

The following explains these prompts in detail. The left two columns identify the prompts and list the available entries. The right-most column provides a further explanation of the entries.

NOTE: Entry of a number other than one specified will give unpredictable results.

A 01	<p>Zone number Enter the first 2-digit zone number to be entered. [*] = continue; system searches for zones not yet entered, then goes to ENROLL SERIAL NUMBER prompt "C" 00 = exit Sequential mode</p>	<p>Enter the first 2-digit zone number to be entered, then press [*]. The system will, starting with this zone number, search for the first transmitter which has <i>all</i> of the following attributes pre-programmed in Zone Programming:</p> <ul style="list-style-type: none"> a) An input type of RF, UR, or BR programmed b) A loop number programmed c) No serial number programmed <p>If the first zone number entered does <i>not</i> have one or more of the above attributes, the system will search its database for the first zone that does, and will display it at the ENROLL SERIAL NUMBER prompt "C". Pressing 00 exits mode, upon which the prompt "83" blinks, indicating the mode is inactive. Press [*] + any field number to go to that field.</p>
C	<p>Enroll serial number Enter transmitter's 7- digit serial number [*] = save entered serial number and advance to next zone [#] = return to previous prompt</p>	<p>Manually enter the 7-digit serial number printed on the transmitter. If you enter an incorrect digit, press the [#] key to backup to that digit and reenter the correct digit.</p> <p>When all 7 digits are entered, press the [*] key. Each digit will be re-displayed, and the keypad will beep once for digits 1-6, 3 times for the last digit. If less than 7 digits are entered, the un-entered digits will display "F." If too many digits have been entered, the first 6 digits will be saved, along with the last digit that was entered (entering 123456789 yields serial number 1234569).</p> <p>If the serial number is correct, press [*] again to save it. The next zone number to be enrolled will display at "C" prompt for 30 seconds. If this is the desired zone number, enter its serial number as described above. If not, either wait 30 seconds or press [#] to display "b" prompt.</p> <p>If the serial number is not correct, press [#], which deletes the number and returns to the ENROLL ZONE prompt (b), allowing you to reenter the number.</p> <p>When the last zone has been entered, the display will remain on that zone. To exit this mode and return to data field program mode, press 00 at the ZONE NUMBER prompt.</p> <p>When you have finished programming all zones, test each using the system's Test mode. Do not use the Transmitter ID Sniffer mode for this, as it will only check for transmission of one zone on a particular transmitter, and NOT the zones assigned to each additional loop.</p>
b ZZ	<p>Enroll zone? 0 = skip enroll; return to ZONE NUMBER prompt 1 = enroll now; return to ENROLL SERIAL NUMBER prompt (C) to enter serial number for this zone.</p>	<p>The system displays the next zone number for which a serial number may be enrolled.</p>

*84 Assign Zone Voice Descriptors

Use this mode to assign voice descriptors for each zone. These are the descriptors that are announced when the system announces any event involving a zone number. Each descriptor can consist of up to 3 words. Press *84 while in Programming mode.

The prompts for *84 are as follows:

84	Voice Descriptors ----- Main Menu prompt
A 01	Zone Number ----- for entering the zone number to be programmed
b	Descriptor 1 ----- for assigning the first word of this zone's descriptor
C	Descriptor 2 ----- for assigning the second word of this zone's descriptor
d	Descriptor 3 ----- for assigning the third word of this zone's descriptor

The following explains these prompts in detail. The left two columns identify the prompts and list the available entries. The right-most column provides a further explanation of the entries.

NOTE: Entry of a number other than one specified will give unpredictable results.

84	Assign zone voice descriptors 0 = exit mode 1 = enter mode	Pressing 1 advances to the next prompt below. Pressing 0 exits mode, upon which this prompt blinks, indicating the mode is inactive. Press [*] + any field number to go to that field.
A zz	Zone number [*] = continue to next prompt (any existing descriptors will be announced, then descriptor 1 will be repeated) 00 = exit voice descriptor mode	Enter the 2-digit zone number for which this descriptor is being assigned, then press [*].
b vv	Descriptor 1 Enter [#] + 2-digit vocabulary index number of first descriptor word for this zone. 6 = accept word and advance to descriptor 2 (descriptor 2 will be announced) 8 = accept word and advance to next zone (prompt A....zz) Press any other key to repeat the selected word.	Enter the first word of the descriptor for the selected zone. Use the [6] or [8] key to advance as described. To change the entered index number before pressing [6] or [8], simply press [#] + desired 2-digit vocabulary index number. If descriptor 1 is not desired, enter [#] + 99 (blank), then press [8] to return to zone number prompt.
C vv	Descriptor 2 Enter [#] + 2-digit vocabulary index number of second descriptor word for this zone. 6 = accept word and advance to descriptor 3 (descriptor 3 will be announced) 8 = accept word and advance to next zone (prompt A....zz) Press any other key to repeat the selected word.	Enter the second word of the descriptor for the selected zone. Use the [6] or [8] key to advance as described. To change the entered index number before pressing [6] or [8], simply press [#] + desired 2-digit vocabulary index number. If descriptor 2 is not desired, enter [#] + 99 (blank), then press [8] to return to zone number prompt.
d vv	Descriptor 3 Enter [#] + 2-digit vocabulary index number of third descriptor word for this zone. 6 or 8 = accept word and advance to next zone (prompt A....zz); zone descriptor will be announced Press any other key to repeat the selected word.	Enter the last word of the descriptor for the selected zone. Use the [6] or [8] key to advance as described. To change the entered index number before pressing [6] or [8], simply press [#] + desired 2-digit vocabulary index number. If descriptor 3 is not desired, enter [#] + 99 (blank), then press [8] to return to zone number prompt.

VOICE VOCABULARY INDEX

00 ½ second pause	F	M	U	70 Custom Word #1
01 ALARM	14 FIRE	25 MAIN	40 UPSTAIRS	71 Custom Word #2
02 ATTIC	15 FLOOR	26 MASTER	41 UTILITY	72 Custom Word #3
	16 FRONT	27 MESSAGE		73 Custom Word #4
		28 MOTION		74 Custom Word #5
	G		W	
	17 GARAGE		42 WINDOW	
	18 GUN	O		
		29 OFFICE		99 Blank (for erasing a previously programmed word)
	H		Y	
	19 HALL		43 YARD	
		P		
	I	30 PATIO		
	20 INSIDE	31 POOL		
			Z	
	K		44 ZONES	
	21 KITCHEN			
		R	45 1 ST	
	L	32 ROOM	46 2 ND	
	22 LAUNDRY		47 3 RD	
	23 LIBRARY	S		
	24 LIVING	33 SHED		
		34 SHOP		
		35 SIDE		
		36 SLIDING		
		37 SMOKE		
		38 STORAGE		
		39 SYSTEM		

SYSTEM WORDS

AC LOSS	EXIT NOW
ARMED	FAULT
AWAY	INSTANT
BYPASSED	LOW BATTERY
CHIME	NOT
DISARMED	READY TO ARM
DISARM SYSTEM NOW	STAY

**85 Record Custom Voice Descriptors*

Use this mode to record up to 5 custom voice descriptors. Press *85 while in Programming mode.

NOTE: Entry of a number other than one specified will give unpredictable results.

85	Assign custom voice descriptors 0 = exit mode 1 = enter mode	Pressing 1 advances to the next prompt below. Pressing 0 exits mode, upon which this prompt blinks, indicating the mode is inactive. Press [*] + any field number to go to that field.
R 7d	Custom descriptor number Enter 7 + d + [*] where d = 0-4, each representing custom word 70, 71, 72, 73, or 74, respectively. Any existing word will be announced. Press [#] to start recorder. Start speaking immediately after the third beep. Speak the desired word clearly near the microphone. Recording stops after 1.5 seconds. 6 = accept word and ready to record next descriptor (prompt A...7d) [#] = re-record descriptor 00 = exit Record mode after pressing 6 to accept word Press any other key to repeat the recorded word.	Record up to 5 custom words.

Remote Programming/Control (Downloading)

General Information

The LYNX can be remotely programmed from an IBM-compatible Personal Computer (PC), a HAYES Modem, and ADEMCO's V-LINK® Software or Compass Downloader for Windows (as specified below).

UL	Downloading may only be performed if a technician is at the site.
----	---

Multiple levels of security protect remote programming of the control against compromise by someone attempting to defeat the system.

1. **Security Code Handshake:** An 8-digit download ID code must be matched between the Control and downloader.
2. **Site-Initiated Remote Programming:** The installer or subscriber initiates the callback from the subscriber premises (by entering Installer Code + # + 1) while disarmed. All parameters can then be downloaded via the phone lines using a personal computer.
3. **Station-Initiated Remote Programming:** The operator calls the site from your office to initiate the download call. The Control hangs up and then calls back the PC via the preprogrammed telephone number. The unit can then be uploaded, downloaded, or controlled from your office.
4. **Telco Handoff:** Allows the installer or subscriber to perform a download session on the call initiated from the site or from local laptop computer.
5. **Data Encryption:** Data passed between the PC and the Control is encrypted for security so that it is very difficult for a foreign device tapped into the phone line to take over communication and substitute system-compromising information.

Equipment required to download to a LYNX at the premises

- An IBM PC compatible computer and appropriate interconnecting cables.
- *Either* a HAYES brand SMARTMODEM 1200 (Level 1.2 or higher external or Level 1.1 or higher [with 4 position DIP switch] internal style), a HAYES brand Optima 336 external, or a HAYES brand Optima 24 Plus FAX96 Modem.
- V-LINK® Downloading Software Diskette or Compass Downloader for Windows (at revision level supporting LYNX).

Initial Download: Enter **Installer Code + # + 5**. This sets field *95 to 4 rings, and system to “no call-back” option. The download computer can then call the subscriber, make connection, and download all programming data.

Flexible Callback: If enabled in field *93, the download operator can temporarily change the last 1, 2, or 3 digits (depending on selection) of the call back number. This allows the control to call back a computer other than the one programmed, which may be helpful at times of high computer traffic. See field *93 for a fuller description.

Remote Programming Information

The downloading system can perform many functions when in communication with the Control. Besides uploading and downloading, the status of the system can be observed and various commands can be initiated, as follows:

- Arm the system in the away mode; disarm the system.
- Bypass a zone.
- Force the system to accept a new program download.
- Shut down communication (dialer) functions (for nonpayment of monitoring fees in an owned system).
- Shut down all security system functions (for nonpayment for a leased system).
- Inhibit local keypad programming (prevents account takeover).
- Command the system to upload a copy of its resident program to the office.
- Set the time
- Read: arming status, AC power status, lists of faulted zones, bypassed zones, zones currently in alarm, zones currently in trouble, and rf sensors with low battery conditions; read control's time.

Notes: After the control and the PC have established valid communication, the keypad will become inactive and will display "CC." The keypad will become active after the download communication is terminated. The detailed operation of the download functions is covered in the installation instructions for the V-LINK® Downloading Software Diskette or Compass Downloader for Windows.

Remote Programming Advisory Notes

- Keypad entries are ignored during the time interval stated above.
- A copy of the program downloaded may printed using the IBM PC-compatible computer's internal report generator, when an optional printer is connected (consult your PC manual for proper printer and connections).
- Program upload or download time is approximately one minute, fifteen seconds for a complete program.

System Operation

Security Codes

Installer Code

The installer programs the 4-digit Installer Code initially as part of the programming procedure. The factory default Installer Code is **4-1-1-2**, but may be changed in field *20.

The Installer Code is the only code that can enter Programming mode and also, in normal operation mode, is used to enter the Master Code, which allows access to the normal functions of the system.

Master Code

In normal operation mode, the Installer Code is used to enter the 4-digit Master Security Code using the keypad:

To enter/change the Master code by installer, enter:

Installer Code + [CODE key] + [02] + desired 4-digit Master Code

To change the Master code by master, enter:

Current Master Code + [CODE key] + [02] + new Master Code + new Master Code again

Secondary User Codes

In normal operation mode, the Master Security Code can be used to assign up to 6 secondary 4-digit security codes, including a Babysitter Code and a Duress Code. The Master Code can also be used to remove secondary codes from the system (individually).

To assign (or change) a secondary security code, enter:

Master Code + [CODE key] + User # (03–08) + desired Secondary Code

The system will emit a single beep when each secondary code has been successfully entered.

To delete a secondary security code, enter:

Master Code + [CODE key] + User # (03–08)

Notes:

All Master and Secondary security codes permit access to the system for arming, disarming, etc.

- The Installer Code can disarm the system only if it was used to arm it. In addition, the Installer Code cannot disarm the system if it was armed by pressing and holding a Quick-Arm button.
- Babysitter Code is User Code No. 7; i.e., it can disarm the system only if it was used to arm it. In addition, the Babysitter Code cannot disarm the system if it was armed by pressing and holding a Quick-Arm button.
- Duress code is User Code No. 8. When this is used to perform any system operation, a special code is sent to the monitoring station. Instruct users to be careful not to use this code for normal usage.
- If a secondary code is inadvertently repeated for different users, the lower user number will take priority.
- Opening and closing reports are sent for the Installer Code as No. 01, with the appropriate subscriber number. Master Code and set of secondary user codes are sent as Nos. 02 and 03–08, respectively, in Contact ID format (with the appropriate subscriber number); in 4+2, it is 1-F, "F" for anything greater than 14. Quick arming is reported as user 00.

Panic Keys

There are three panic key pairs that, if programmed, can be used to manually initiate alarms and send a report to the central station.

Each can be individually programmed for 24-hour silent, audible, personal or fire emergency responses. The panic function is activated when both keys of the appropriate key pair are pressed at the same time, or the appropriate lettered key is pressed for at least 2 seconds.

The panic functions are identified by the system as follows:

Keys	Displayed as Zone
[1] & [*]	95
[*] & [#]	99
[3] & [#]	96

Important: For the silent panic functions to be of practical value, the system must be connected to a central station.

Keypad Functions

The keypad allows the user to arm and disarm the system, and perform other system functions, such as bypassing zones. Zone and system conditions (alarm, trouble, bypass) are displayed in the display window.

When an alarm occurs, keypad sounding and external sounding will occur, and the zone(s) in alarm will be displayed on the keypad. Pressing any key will silence the keypad sounder for 10 seconds (only once). Disarming the system will silence both keypad and external sounders. When the system is disarmed, any zones that were in an alarm condition during the armed period will be displayed (memory of alarm). To clear this display, simply repeat the disarm sequence (enter the security code and press the OFF key). The keypad also features chime annunciation, and 3 panic key pairs for silent, audible, fire or personal emergency alarms. These keys can notify the central station of an alarm condition, if that service is connected.

The following is a summary of system functions. For detailed information concerning system functions, refer to the User's Manual. (Empty boxes represent the user's security code, except where shown otherwise.)

Security Functions

Checking system status: -- (high level messages); press again for secondary messages

To arm in STAY mode: - + (or installer code + [3])

To restart exit delay: ----- (applies only if system is armed in Stay mode)

To arm in AWAY mode: + (or installer code + [2])

To arm with NO DELAY: + or +

To arm if Quick Arm is programmed: or (hold down for at least 2 seconds)

To disarm the system and silence alarms: +

To bypass a zone(s): ----- + + 2-digit zone number(s)

To turn Chime mode on or off: +

Message Center

To record a message: ----- +

To stop recording before end of 20 seconds:

To play back a message: - +

NOTE: If a wireless keypad (5827/5827BD) has been installed and is programmed for Quick Arming, it cannot be used to activate message playback or to adjust the volume. In this case, you must use the master keypad to perform these functions.

Volume Control

To adjust message playback/system announcement volume: + + [3] or [6]

To mute system announcements: + +

To restore announcement sounding: + + [3] or [6]

Other Functions

To set the time and date: - + + [63]

To activate or deactivate devices 1-6: + or + device number

To activate or deactivate devices 7 & 8: + + or + dev. no.

To add a user code: ----- * + + user number + user's code (*master code)

To delete a user code (except Master Code): * + + user number (* master code)

To turn Test mode on: ---- +

To turn Test mode off: ---- +

To use the defined AUX function: Press and hold key 2 secs (4 beeps) +

To define the AUX function, refer to the procedure in the *Aux Function* section of the User Manual.

To send message to pager: Press and hold key 2 seconds (4 beeps)

Quick Arm Note: The installer code and babysitter code cannot disarm the system if it was armed with the Quick Arm method.

Powerline Carrier Devices

If Powerline Carrier Devices are used, two keypad entries available to the user are included. They can manually activate or deactivate the device(s) for starting or stopping some action, such as turning lights on or off, etc.

These keypad entries are:

Security Code* + [#] + [4] + Device # activates (starts) that device.

Security Code* + [#] + [7] + Device # de-activates (stops) that device.

* Code is required for devices 7 and 8. Code is not required for devices 1-6.

Exit Error Alarm Displays

If programmed:

- A display of **"CA" and a zone indication** will appear if an exit or interior zone contained a fault during closing at the time the exit delay ended (e.g., exit door left open), **but the system was disarmed during the entry delay time**. The alarm sounder and keypad sound continuously, but stop when the system is disarmed. No message will be transmitted to the central station.
- A display of **"EA" and a zone indication** will appear if an exit or interior zone contained a fault during closing at the time the exit delay ended, **but the system was NOT disarmed during the entry delay time**. The alarm sounder and keypad sound continuously until the system is disarmed (or timeout occurs). An Exit Alarm message is sent to the central station.
- The **"EA" display, etc.** will also result if an alarm from an exit or interior zone occurs within two minutes after the end of an exit delay.

In any of the above cases, use a second OFF sequence (code plus OFF key) to clear the display.

Trouble Conditions

The word "FAULT" on the keypad's display, accompanied by a rapid "beeping" at the keypad, indicates that there is a trouble condition in the system. The audible warning sound can be silenced by pressing any key. Instruct users to call for service immediately upon seeing any of the following messages.

"Fault" and "Battery" Displays

- A display of **"FAULT" and one or more zone numbers** indicates that a problem exists with the displayed zone(s) and requires attention.
After correcting the problem, the display can be cleared by entering the security code plus the OFF key twice.
- The fault condition may also be caused by some change in the environment that prevents the built-in receiver from receiving signals from a particular wireless sensor.
- A display of **"LOW BAT" with no zone number** indicates that the system's main standby battery is weak.
- A display of **"LOW BAT" with a zone number and a once-per-45 seconds "beeping" at the keypad** indicates that a low battery condition exists in the wireless sensor displayed (zone "00" indicates a wireless keypad). If the battery is not replaced within 30 days, a "FAULT" display may occur.
NOTE: Some wireless sensors contain a nonreplaceable long-life battery which requires replacement of the entire unit at the end of battery life (e.g., Nos. 5802, 5802CP).

Power Failure

- **If there is no display at all, and both indicators are not lit**, operating power for the system has stopped and the system is inoperative.
- **If the display is lit and the AC display is off**, the system is operating on battery power only.
- **During an AC power loss**, the backlighting will turn off and the indicators will flicker slightly to minimize deep discharge of the battery.

Other Displays

dI = Busy-Standby: Displayed upon power-up. After approximately 1 minute* the green "READY" LED should light. If the "dI" remains displayed for more than 1 minute, the system is disabled.

* To bypass the 1-minute delay, press [#] + [0].

CC = Modem Comm: The system is in communication with the central station for change of function or status verification.

FC = Comm. Failure: A communication failure has occurred. This message clears only when the system is subsequently armed.

90 = RF Jam: The system has detected an RF jamming condition or excessive interference.

Testing the System

Test Mode

After installation is completed, the security system should be carefully tested, as follows.

1. With the system in the disarmed state, check that all zones are intact. If the READY LED is not lit, press the [*] key to display the faulted zone(s). Restore faulted zone(s) if necessary, so that **READY** LED lights. Fault and restore every sensor individually to assure that it is being monitored by the system.
2. Enter the **security code** and press the **TEST** key. The outside sounder will sound for 1 second and all the LED segments on the keypad display light for 3 seconds. The keypad should sound 3 beeps each time a contact is faulted. A test report should be transmitted (if programmed) to the central station immediately. If the backup battery is discharged or missing, the sounder may not turn on and a LOW BATTERY report will be transmitted with a TEST report. The keypad will beep once every 45 seconds as a reminder that the system is in the Test mode.
3. To turn off the Test mode enter **security code** and press the **OFF** key.

NOTES:

- Triggering a zone set to Arm AWAY, Arm STAY, or Disarm will take the system out of Test and cause that action.
- BR type transmitters do not display during Test mode (keypad beeps only)

Armed System Test

Alarm messages will be sent to the central station during the following tests 1 and 2. Notify them in advance that tests will be in progress.

1. Arm the system and fault one or more zones. After 15 seconds (if optional dialer delay is selected), silence alarm sounder(s) by entering the **code** and pressing **OFF**. Check entry/exit delay zones.
2. Check the keypad-initiated alarms that are in the system by pressing the Panic key pairs. If the system has been programmed for audible emergency, the keypad will emit a steady alarm sound, and “**ALARM**” and **zone number** will be displayed. Silence the alarm by entering the **security code** and pressing **OFF**.
If the system has been programmed for silent emergency, there will be no audible alarms or displays, but a report will be sent to the central station.
3. If Powerline Carrier Devices have been installed, test their programmed action.
4. Notify the central station when all tests are finished, and verify results with them.
5. To test the wireless part of the system and the RF receiver, perform the two additional tests described in the *Installing Wireless Zones* section: Sniffer mode and Go/No Go Test.

NOTE: **System Test mode** (code + test) and **Go/No Go Test** (code + [#] + 2) will be **automatically terminated** after 4 hours if the installer or user does not manually terminate it. This ensures that fire and panic zones will not remain disabled.

However, **Sniffer mode** (installer code + # + 3) **does not automatically expire. You must manually exit (Installer/User Code + OFF) Sniffer mode to return to normal operation.**

TO THE INSTALLER

Regular maintenance and inspection (at least annually) by the installer and frequent testing by the user are vital to continuous satisfactory operation of any alarm system.

The installer should assume the responsibility of developing and offering a regular maintenance program to the user as well as acquainting the user with the proper operation and limitations of the alarm system and its component parts. Recommendations must be included for a specific program of frequent testing (at least weekly) to ensure the system's proper operation at all times.

System Communication

This section provides an explanation of formats this system accommodates for reporting alarms and other system conditions to the central station. The process of a successful transmission consists of both the method of communication between the control panel and the central station receiver, and the actual way the information is sent and displayed at the central station.

Communication Overview

When the panel calls the central station receiver, it waits to hear a “handshake” frequency from the receiver to confirm that the receiver is on-line and ready to receive its message. Once the panel hears the handshake it is programmed to listen for, it sends its message. The panel then waits for a “kissoff” frequency from the receiver acknowledging that the message was received and understood.

If the handshake frequency is not given or is not understood by the panel, the panel will not send its message. Once the handshake frequency is received and understood by the panel, the panel will send its message. If there is an error in the transmission (the receiver does not receive a “valid” message), the kissoff frequency will not be given by the central station receiver.

The panel will make eight attempts to the primary telephone number and eight attempts to the secondary telephone number (if programmed) to get a valid message through. If the panel is not successful after its numerous attempts, the keypad will display “FC.” If the secondary number is a pager, “FC” displays after the first 8 attempts to the primary number.

The following chart defines the three sets of (handshake/kissoff) frequencies that the panel supports, and the different formats that can be sent for each.

FORMAT	HANDSHAKE	TRANSMITS DATA	KISSOFF	TRANSMIT TIME
Low Speed 3+1 4+1 4+2	1400Hz	1900Hz (10PPS)	1400Hz	Under 15 secs. (Standard report)
Sescoa/Rad 3+1 4+1 4+2	2300Hz	1900Hz (20PPS)	2300Hz	Under 10 secs. (Standard report)
Express 4+2	1400–2300Hz	DTMF (10 cps)	1400Hz	Under 3 secs.
Contact ID	1400–2300Hz	DTMF (10 cps)	1400Hz	Under 3 secs.

Report Code Formats

3+1 and 4+1 Standard Formats	Comprise a 3- (or 4-) digit subscriber number and a single digit report code (e.g. alarm, trouble, restore, open, close, etc).
3+1 and 4+1 Expanded Formats	Comprise a 3- (or 4-) digit subscriber number, and a 2-digit report code. The first digit is displayed on the first line, followed by a second line where the first digit is repeated 3 (or 4) times and followed by the second digit. This is the “expanded” digit.
4+2 Format	Comprises a 4-digit subscriber number and 2-digit report code.
ADEMCO Contact ID Reporting Format	Comprises a 4-digit subscriber number, 1-digit event qualifier (“new” or “restore”), 3-digit event code, and 3-digit zone number, user number, or system status number (see the following page).

The following table shows the message formats for 3+1, 4+1 and 4+2 reports, where:

SSS or SSSS = Subscriber ID	C = Close Code (1st Digit)
A = Alarm Code (1st digit)	U = User Number (in hex)
Z = Typically Zone Number* (2nd digit)	Gg = Test Code (1st & 2nd digits)
Tt = Trouble Code (1st & 2nd digits)	R = Alarm Restore Code
Bb = Bypass Code (1st & 2nd digits)	R _T t = Trouble Restore Code (1st & 2nd digits)
EA _C = AC Loss Code (1st & 2nd digits)	R _B b = Bypass Restore Code (1st & 2nd digits)
LL _B = Low Battery Code (1st & 2nd digits)	R _A A _C = AC Restore Code (1st & 2nd digits)
O = Open Code (1st Digit)	R _L L _B = Battery Restore Code (1st & 2nd digits)

Zone numbers for: [] & [#], or [B] = 99; [1] + [*], or [A] = 95; [3] + [#], or [C] = 96; Duress = 92

Report	3+1/4+1 Standard	3+1/4+1 Expanded	4+2
Alarm	SSS(S) A	SSS(S) A AAA(A) Z	SSSS AZ
Trouble	SSS(S) T	SSS(S) T TTT(T) t	SSSS Tt
Bypass	SSS(S) B	SSS(S) B BBB(B) b	SSSS Bb
AC Loss	SSS(S) E	SSS(S) E EEE(E) A _C	SSSS EA _C
Low Batt	SSS(S) L	SSS(S) L LLL(L) L _B	SSSS LL _B
Open	SSS(S) O	SSS(S) O OOO(O) U	SSSS OU
Close	SSS(S) C	SSS(S) C CCC(C) U	SSSS CU
Test	SSS(S) G	SSS(S) G GGG(G)g	SSSS Gg
Restore Alarm	SSS(S) R	SSS(S) R RRR(R) Z	SSSS RZ
AC Restore	SSS(S) R _A	SSS(S) R _A R _A R _A R _A (R _A)A _C	SSSSR _A A _C
LoBat Res.	SSS(S) R _L	SSS(S) R _L R _L R _L R _L (R _L)L _B	SSSS R _L L _B
Trouble Res.	SSS(S) R _T	SSS(S) R _T R _T R _T R _T (R _T)t	SSSS R _T t
Bypass Res.	SSS(S) R _B	SSS(S) R _B R _B R _B R _B (R _B)b	SSSS R _B b

ADEMCO Contact ID Reporting takes the following format: CCCC Q EEE GG ZZZ

where: CCCC = Customer (subscriber) ID

Q = Event qualifier, where: E = new event, and R = restore

EEE = Event code (3 hex digits) (for a complete list of event codes, refer to the central office receiver manual)

GG = Always "00"

ZZZ = Zone/Contact ID number reporting the alarm, or user number for open/close reports. System status messages (AC Loss, Walk Test, etc.) contain zeroes in the ZZZ location.

TABLE OF CONTACT ID EVENT CODES

Code	Definition
110	Fire Alarm
121	Duress
122	Alarm, 24-hour Silent
123	Alarm, 24-hour Audible
131	Alarm, Perimeter
132	Alarm, Interior
134	Alarm, Entry/Exit
135	Alarm, Day/Night
146	Silent Burglary
150	Alarm, 24-Hour Auxiliary
301	AC Power
302	Low System Battery/Battery Test Fail
344	RF Jam Detected
373	Fire Loop Trouble

Code	Definition
374	Exit Error Alarm
380	Global Trouble, Trouble Day/Night
381	RF Supervision Trouble
383	RF Sensor Tamper
384	RF Sensor Low Battery
401	Disarmed, Armed AWAY (NO DELAY), Armed AWAY
406	Cancel by User
407	Remote Arm/Disarm (Downloading)
408	Quick Arm AWAY/NO DELAY
441	Disarmed/Armed STAY/NO DELAY, Quick Arm STAY/NO DELAY
570	Bypass
602	Periodic Test
606	AAV to follow
607	System Test
623	Event Log 80% Full

NOTE: The following codes are logged in the event log upon occurrence but do not get reported:

305 = System Reset

627 = Keypad Program Mode Entry

Troubleshooting Guide

SYSTEM (including Wireless)

SYMPTOM	POSSIBLE CAUSE	REMEDY
1. Transmitter signal not received at control.	1a. Transmitter not properly powered. 1b. If Transmitter is 5827/5827BD, House Code not set in field *24, or transmitter is not set to same House Code set in that field. 1c. Transmitter is located too far from RF receiver. 1d. There is metal shielding between transmitter and RF receiver. 1e. Transmitter is malfunctioning. 1f. Transmitter No. (zone) is not programmed.	1a. Check or change transmitter's battery. 1b. Check code switches inside transmitter. Must match with RF House Code programmed. 1c. Move transmitter or RF receiver. 1d. Check for large metal obstructions, then relocate transmitter if necessary. 1e. Verify by activating control with another, similar transmitter. If O.K. now, return defective transmitter. 1f. Verify programming.
2. Transmitter zone number appears during Transmitter Sniffer mode, but does not clear.	2a. Transmitter zone type (ZT) is set to 00 (Not Used). 2b. Transmitter battery not installed. 2c. 5800 System transmitter not "entered" in system.	2a. Set ZT to a valid active zone type in field *56. 2b. Install proper battery. 2c. "Enter" unit in field *56 or *83.
3. Low battery message on keypad. 3a. "Low Bat" (no zone Nos.) 3b. "Low Bat" + "00". 3c. "Low Bat" + "nn".	3a. System battery is low or missing. 3b. Remote RF keypad battery is low. 3c. Transmitter for zone "nn" has a low battery. 3d. System low battery	3a. Replace system battery. 3b. Replace battery in the RF keypad. 3c. Replace the battery in the displayed transmitter. 3d. Replace system battery
4. Periodic beep(s) from keypad.	4a. System is in Test mode. 4b. A transmitter low battery has occurred and is displayed. 4c. A supervision fault has occurred.	4a. Enter Code + OFF to exit Test mode. 4b. Enter Code + OFF and replace the battery. 4c. Check the transmitter indicated. Restore communication to the receiver to cancel the condition.
5. With 5800 System, there is no response to a transmitter in normal operation, although zone number clears during Transmitter Sniffer mode.	Put control in Test mode. If zone does not respond, try operating the tamper switch or another input to the transmitter. 5a. If another input causes the zone to be displayed, the wrong input was "entered" when programming. 5b. If no response at all from this transmitter, this physical transmitter has not been entered by the system. Transmitter Sniffer display is being cleared by another unit programmed for this zone.	5a. Delete input's serial number (not the zone), and enter the proper input (see field *56). 5b. Determine which transmitter is programmed for this zone and reprogram as necessary.
6. Nuisance or phantom alarm.	6a. Sensors not properly installed, wired, or monitored. 6b. Universal transmitter (5817) programmed wrong.	6a. Check installation to see if in accordance with established procedure. 6b. Check programming switches on transmitter.
7. Intrusion alarm for no apparent reason.	7a. Protected door or window opened while system armed. 7b. Improper user operation of exit/entry delays. 7c. Magnets located too far from switches, and/or doors and windows not properly aligned.	7a. Check with all occupants of protected home. 7b. Check setting of entry and exit delays. 7c. Check all openings for proper switch and magnet orientation.

TROUBLESHOOTING GUIDE (continued)

CONTROL

SYMPTOM	POSSIBLE CAUSE	REMEDY
1. The word "AC" is not displayed.	1a. Interrupted AC power supply.	1a. Check transformer connection and powerline circuit breaker.
2. Digital communicator message not being received.	2a. System in Test mode. 2b. Telephone connection not secure. 2c. Digital communicator malfunctioning. 2d. Telephone number in program needs prefix or access code. 2e. Telephone call to central monitoring station requires operator assistance.	2a. Remove from Test mode. 2b. Check all connections. 2c. Check with a different LYNX. 2d. Program prefix or access code into the LYNX. 2e. System cannot work in this situation.
3. Does not arm properly. READY light not on.	Open or faulted zone(s)	Check for faulted zones and make intact, or use Bypass arming, if desired.
4. System doesn't respond to keystrokes on keypad. 4a. "CC" displayed. 4b. "d1" displayed.	4a. System is in communication with downloader at central station. 4b. System has just been powered and is in its one minute initialization.	4a. Wait until download session is finished. 4b. Wait for initialization to finish, or bypass this time by pressing '#' + '0.'

SMOKE DETECTOR

SYMPTOM	POSSIBLE CAUSE	REMEDY
1. Detector alarms, no apparent reason.	1a. Dust, dirt in sensing chamber. 1b. Improper location. 1c. Unit malfunctioning.	1a. Clean unit's sensing chamber with vacuum cleaner per unit's instructions. 1b. See unit's instructions for locations to avoid. Relocate as necessary. 1c. Replace detector.
2. Detector's siren sounds.	2a. Unit not receiving required power. 2b. Unit malfunctioning.	2a. Check for proper installation of battery. Try new battery. 2b. Replace detector.

Contacting Technical Support

PLEASE, before you call Technical Support, be sure you:

- **READ THE INSTRUCTIONS!**
- **Check all wiring connections.**
- **Determine that the power supply and/or backup battery are supplying proper voltages.**
- **Verify your programming information where applicable.**
- **Note the proper model number of this product, and the version level (if known) along with any documentation that came with the product.**
- **Note your ADEMCO customer number and/or company name.**

Having this information handy will make it easier for us to serve you quickly and effectively.

You may contact Technical Support via Toll Free Fax. Please include your return fax number. You will receive a reply within 24 hours. You may also contact Technical Support via modem to ATLAS-BBS, Tech Support's Electronic Bulletin Board System. Replies are posted within 24 hours.

<i>Technical Support:</i>	1-800-645-7492 (8 a.m.-8 p.m. E.S.T.)
<i>Technical Support Fax Number:</i>	1-800-447-5086
<i>ATLAS-BB Electronic Bulletin Board System:</i>	1-516-496-3980
<i>(1200 - 9600 Baud, 8 Data Bits, 1 Start/Stop Bit, No Parity)</i>	
<i>ATLAS-FAX FAXBACK Automated Fax Retrieval System:</i>	1-800-573-0153 or 1-516-921-6704 / ext. 1667
<i>World Wide Web Address:</i>	HTTP://WWW.ADEMCO.COM

Regulatory Agency Statements

UL NOTICE: This is a "Grade A" residential system.

FCC STATEMENT

FCC ID: CFS8DLLYNX
CANADA: 17481021165A

THIS DEVICE COMPLIES WITH PART 15 OF FCC RULES. OPERATION IS SUBJECT TO THE FOLLOWING TWO CONDITIONS: (1) THIS DEVICE MAY NOT CAUSE HARMFUL INTERFERENCE, AND (2) THIS DEVICE MUST ACCEPT ANY INTERFERENCE RECEIVED, INCLUDING INTERFERENCE THAT MAY CAUSE UNDESIRE OPERATION.

FEDERAL COMMUNICATIONS COMMISSION (FCC) Part 15 STATEMENT

This equipment has been tested to FCC requirements and has been found acceptable for use. The FCC requires the following statement for your information:

This equipment generates and uses radio frequency energy and if not installed and used properly, that is, in strict accordance with the manufacturer's instructions, may cause interference to radio and television reception. It has been type tested and found to comply with the limits for a Class B computing device in accordance with the specifications in Part 15 of FCC Rules, which are designed to provide reasonable protection against such interference in a residential installation. However, there is no guarantee that interference will not occur in a particular installation. If this equipment does cause interference to radio or television reception, which can be determined by turning the equipment off and on, the user is encouraged to try to correct the interference by one or more of the following measures:

- If using an indoor antenna, have a quality outdoor antenna installed.
- Reorient the receiving antenna until interference is reduced or eliminated.
- Move the radio or television receiver away from the receiver/control.
- Move the antenna leads away from any wire runs to the receiver/control.
- Plug the receiver/control into a different outlet so that it and the radio or television receiver are on different branch circuits.

If necessary, the user should consult the dealer or an experienced radio/television technician for additional suggestions. The user or installer may find the following booklet prepared by the Federal Communications Commission helpful: "Interference Handbook"

This booklet is available from the U.S. Government Printing Office, Washington, DC 20402.

The user shall not make any changes or modifications to the equipment unless authorized by the Installation Instructions or User's Manual. Unauthorized changes or modifications could void the user's authority to operate the equipment.

FEDERAL COMMUNICATIONS COMMISSION (FCC) Part 68 STATEMENT

This equipment complies with Part 68 of the FCC rules. On the front cover of this equipment is a label that contains, among other information, the FCC registration number and ringer equivalence number (REN) for this equipment. If requested, this information must be provided to the telephone company.

This equipment uses the following jacks: An RJ31X is used to connect this equipment to the telephone network.

The REN is used to determine the quantity of devices which may be connected to the telephone line. Excessive RENs on the telephone line may result in the devices not ringing in response to an incoming call. In most, but not all areas, the sum of the RENs should not exceed five (5.0). To be certain of the number of devices that may be connected to the line, as determined by the total RENs, contact the telephone company to determine the maximum REN for the calling area.

If this equipment causes harm to the telephone network, the telephone company will notify you in advance that temporary discontinuance of service may be required. If advance notice is not practical, the telephone company will notify the customer as soon as possible. Also, you will be advised of your right to file a complaint with the FCC if you believe necessary.

The telephone company may make changes in its facilities, equipment, operations, or procedures that could affect the operation of the equipment. If this happens, the telephone company will provide advance notice in order for you to make the necessary modifications in order to maintain uninterrupted service.

If trouble is experienced with this equipment, please contact the manufacturer for repair and warranty information. If the trouble is causing harm to the telephone network, the telephone company may request you remove the equipment from the network until the problem is resolved.

There are no user serviceable components in this product, and all necessary repairs must be made by the manufacturer. Other repair methods may invalidate the FCC registration on this product.

This equipment cannot be used on telephone company-provided coin service. Connection to Party Line Service is subject to state tariffs.

When programming or making test calls to an emergency number, briefly explain to the dispatcher the reason for the call. Perform such activities in the off-peak hours; such as early morning or late evening.

Specifications

LYNX SECURITY CONTROL

1. Physical: 10-3/8" W x 7-1/8" H x 1-3/4" D

2. Electrical:

VOLTAGE INPUT: 9VAC from plug-in 15VA transformer,

BACKUP BATTERY: one 9-volt alkaline battery (recommended: Duracell's PC1604 ProCell) or 6 1.5V "AA" alkaline batteries (e.g., Duracell MN1500)

ALARM SOUNDER: Piezo = 6-14VDC, 30mA max/ Bell = 6-14VDC, 120mA max (e.g., ADEMCO's WAVE2EX)

3. Communication:

FORMATS SUPPORTED:

ADEMCO Express,

10 characters/sec, DTMF (TouchTone) Data Tones, 1400/2300Hz ACK, 1400Hz KISSOFF.

ADEMCO Contact ID Reporting,

10 characters/sec., DTMF (TouchTone) Data Tones, 1400/2300Hz ACK, 1400Hz KISSOFF.

ADEMCO Low Speed, 10 pulses/sec, 1900Hz Data Tone, 1400Hz ACK/KISSOFF.

Radionics/SESCOA, 20 pulses/sec, 1800Hz Data Tone, 2300Hz ACK/KISSOFF. Can report 0-9, B-F.

Line Seize: Double Pole

Ringer Equivalence: 0.6B

FCC Registration No.: 5GBUSA-25623-AL-E

Canada: 17481021165A

4. Maximum Zone 1 Resistance: 300 ohms, excluding 2k ohm EOLR

LYNX PROGRAMMING DEFAULT TABLES (boldfaced rows indicate defaults that differ between tables)

Function	Table 1	Table 2	Table 3	Table 4	Table 5
*20 Installer code	4112	4112	4112	4112	4112
*21 Quick arm enable	1	1	1	1	1
*22 Keypad backlight timeout	0	0	0	0	0
*23 Forced bypass	0	0	0	0	0
*24 RF house ID code	0,0	0,0	0,0	0,0	0,0
*25 Powerline carrier device house code	0	0	0	0	0
*26 Chime-by-zone	1	1	1	1	1
*27 Real-time clock display	1	1	1	1	1
*29 Daylight saving time start/end month	4,10	4,10	4,10	4,10	4,10
*30 Daylight saving time start/end weekend	1,5	1,5	1,5	1,5	1,5
*31 Single alarm sounding per zone	0	0	0	0	0
*32 Fire sounder timeout	0	0	0	0	0
*33 Alarm bell timeout	1	1	1	1	1
*34 Exit delay	7,0	7,0	7,0	7,0	7,0
*35 Entry delay 1 (zone type 01)	3,0	3,0	3,0	3,0	3,0
*36 Entry delay 2 (zone type 02)	6,0	6,0	6,0	6,0	6,0
*37 Audible exit warning/quick exit	1,1	1,1	1,1	1,1	1,1
*38 Confirmation of arming ding	0	0	0	0	0
*39 Power up in previous state	1	1	1	1	1
*40 PABX access code	---	---	---	---	---
*41 Primary phone number	---	---	---	---	---
*42 Secondary phone number	---	---	---	---	---
*43 Primary subscriber account number	15,15,15,15	15,15,15,15	15,15,15,15	15,15,15,15	15,15,15,15
*44 Secondary subscriber account number	---	---	---	---	---
*47 Phone system select	1	1	1	1	1
*48 Report format	7,0	7,7	7,0	7,7	7,0
*49 Split/dual reporting	0	9	0	9	0
*50 15 second dialer delay (burglary)	0	0	0	0	0
*51 Periodic test report	0	0	0	0	0
*52 First test report offset	2	2	2	2	2
*53 Sescoa/radionics select	0	0	0	0	0
*56 Zone programming	See *56 table	See *56 table	See *56 table	See *56 table	See *56 table
*58 RF jam detection	0	0	0	0	0
*59 Exit error report code	1	1	1	1	1
*60 Trouble report code	1,0	1,0	1,0	1,0	1,0
*61 Bypass report code	1,0	1,0	1,0	1,0	1,0
*62 AC loss report code	1,0	1,0	1,0	1,0	1,0
*63 Low battery Report code	1,0	1,0	1,0	1,0	1,0
*64 Test report code	1,0	1,0	1,0	1,0	1,0
*65 Open report code	1	1	1	1	1
*66 Arm away/stay report code	1,1	1,1	1,1	1,1	1,1
*67 RF transmitter low battery report code	1,0	1,0	1,0	1,0	1,0
*68 Cancel report code	1,0	1,0	1,0	1,0	1,0
*70 Alarm restore codes	1	1	1	1	1
*71 Trouble restore report code	1,0	1,0	1,0	1,0	1,0
*72 Bypass restore report code	1,0	1,0	1,0	1,0	1,0
*73 AC restore report code	1,0	1,0	1,0	1,0	1,0
*74 Low battery restore report code	1,0	1,0	1,0	1,0	1,0
*75 RF transmitter low battery restore report code	1,0	1,0	1,0	1,0	1,0
*76 Test restore report code	1,0	1,0	1,0	1,0	1,0
*80 Powerline Carrier Devices	See *80 table	See *80 table	See *80 table	See *80 table	See *80 table
*81 Zone lists for devices	See *81 table	See *81 table	See *81 table	See *81 table	See *81 table
*84 Assign zone voice descriptors	See *84 table	See *84 table	See *84 table	See *84 table	See *84 table
*87 Auxiliary Function/ 1-button paging	0	0	0	0	0
*88 Pager characters	---	---	---	---	---
*89 Event log 80% full report code	0,0	0,0	0,0	0,0	0,0
*90 Event logging	15	3	3	3	15
*91 Future use	0	0	0	0	0
*92 Number of reports in armed	0	0	0	0	0
*93 Flexible call back	0	0	0	0	0
*94 Download phone number	---	---	---	---	---
*95 Ring detect count for downloading	0	0	0	0	0
Default Master Code	1,2,3,4	1,2,3,4	1,2,3,4	1,2,3,4	1,2,3,4

By activating *96, Field 43, and 44 will be changed to 15, 15, 15, 15.

***56 ZONE ASSIGNMENT/ALARM REPORT CODES FOR TABLE 1 (TABLE 5 IS SAME A TABLE 1)**

Zone No.	Zone Type	Alarm Code	Input Type	Loop Number	Zone Descriptor
1	0	0	---	---	
2	1	10	3 (RF)	2	16,12 (FRONT DOOR)
3	1	10	3 (RF)	2	04,12 (BACK DOOR)
4	3	10	3 (RF)	2	42 (WINDOW)
5	10	10	3 (RF)	1	28,10 (MOTION DETECTOR)
26	21	10	5 (BR)	3	
27	22	10	5 (BR)	2	
28	23	0	5 (BR)	4	
29	23	0	5 (BR)	1	
30	21	10	5 (BR)	3	
31	22	10	5 (BR)	2	
32	23	0	5 (BR)	4	
33	23	0	5 (BR)	1	
92	---	10	---	---	
99	6	10	---	---	

NOTE: Zone 1 is a hardwire zone; Zone 2 to 41 are RF zones; Zone 92 is Duress; Zone 99 is keypad panic

***56 ZONE ASSIGNMENT/ALARM REPORT CODES FOR TABLE 2**

Zone No.	Zone Type	Alarm Code	Input Type	Loop Number	Zone Descriptor
1	0	0	---	---	
2	1	10	3 (RF)	2	16,12 (FRONT DOOR)
3	1	10	3 (RF)	2	04,12 (BACK DOOR)
4	3	10	3 (RF)	2	42 (WINDOW)
5	10	10	3 (RF)	1	28,10 (MOTION DETECTOR)
6	9	10	3 (RF)	1	37,10 (SMOKE DETECTOR)
26	21	10	5 (BR)	3	
27	22	10	5 (BR)	2	
28	23	0	5 (BR)	4	
29	23	0	5 (BR)	1	
30	21	10	5 (BR)	3	
31	22	10	5 (BR)	2	
32	23	0	5 (BR)	4	
33	23	0	5 (BR)	1	
92	---	10	---	---	
99	6	10	---	---	

NOTE: Zone 1 is a hardwire zone; Zone 2 to 41 are RF zones; Zone 92 is Duress; Zone 99 is keypad panic

***56 ZONE ASSIGNMENT/ALARM REPORT CODES FOR TABLES 3 & 4**

Zone No.	Zone Type	Alarm Code	Input Type	Loop Number	Zone Descriptor
1	0	0	---	---	
2	1	10	3 (RF)	2	16,12 (FRONT DOOR)
3	1	10	3 (RF)	2	04,12 (BACK DOOR)
4	3	10	3 (RF)	2	42 (WINDOW)
5	3	10	3 (RF)	2	42 (WINDOW)
6	3	10	3 (RF)	2	42 (WINDOW)
7	3	10	3 (RF)	2	42 (WINDOW)
8	10	10	3 (RF)	1	28,10 (MOTION DETECTOR)
9	9	10	3 (RF)	1	37,10 (SMOKE DETECTOR)
26	21	10	5 (BR)	3	
27	22	10	5 (BR)	2	
28	23	0	5 (BR)	4	
29	23	0	5 (BR)	1	
30	21	10	5 (BR)	3	
31	22	10	5 (BR)	2	
32	23	0	5 (BR)	4	
33	23	0	5 (BR)	1	
92	---	10	---	---	
99	6	10	---	---	

NOTE: Zone 1 is a hardwire zone; Zone 2 to 41 are RF zones; Zone 92 is Duress; Zone 99 is keypad panic

LYNX *80 DEFAULT TABLE: APPLY TO DEFAULT TABLES 2 and 4 (devices 2-7 have no default values)

Device Number	Action	Start		Stop	
		Event	Zone List	Restore of Zone List	Zone type System operation
1	2	2	1		
8**	2			33	36

** NOTE: If using an X-10 Powerhouse Security SH10A siren as device 8, you must change the device action default to "3" if using default table 2 or 4.

LYNX *81 ZONE LIST FOR OUTPUT DEVICES DEFAULT TABLE: Apply To Default Table 1 - 5. Default table 5 is the same as table 1.

Zone List 1	28, 32
Zone List 2	29, 33
Zone List 3	2, 3

– Index –

B

*56 Zone Programming Mode.....	17
*56 Zone Programming Mode.....	20
*80 Device Programming Menu Mode.....	20, 21, 24
*81 Zone List Menu Mode.....	20, 27
*83 Sequential Mode.....	12, 20, 21, 23, 28
*84 Assign Zone Voice Descriptors....	20, 23, 29
*85 Record Custom Voice Descriptors....	20, 30
*96 Initialize Download Id And Subscriber Acct. No. For Downloading.....	20
*97 Set All Program Fields To 1 Of 5 Sets Of Default Values.....	20
*98 Exits Programming Mode.....	20
*99 Exits Programming Mode.....	20
1.5V “AA” Alkaline Batteries.....	8
1332.....	8
15-Second Dialer Delay.....	17, 42
1-Button Paging.....	4
24-Hour Audible Alarm.....	13
24-Hour Silent Alarm.....	13, 32
5800 Series Transmitters.....	9
5801.....	9, 10, 28
5802.....	9, 10, 34
5802CP.....	9, 10, 34
5802MN.....	9, 10
5804.....	9, 10
5804BD.....	9, 15
5816.....	28
5827.....	9, 11, 15, 38
5827BD.....	9, 15, 38
9-Volt Alkaline Battery.....	8

A

AC Power Loss.....	8
AC Restore Report Code.....	18, 42
ADEMCO Contact ID Reporting.....	17
ADEMCO Express.....	17, 41
ADEMCO Low Speed.....	17, 41
Alarm Bell Timeout.....	15, 42
Alarm Output.....	4
Alarm Restore Report Code.....	18, 42
Alarm Sounder.....	41
Arm Away/Stay Report Code.....	18, 42
Arm-Away.....	14
Arm-Stay.....	14
Assign Custom Voice Descriptors.....	30
Assign Zone Voice Descriptors....	12, 23, 29, 42
Audible Exit Warning/Quick Exit.....	16, 42
AUX Function/1-Button Paging.....	19, 33, 42
Away Mode.....	33

Babysitter Code.....	32
Back Plate.....	5
Backlighting.....	15
Backup Battery.....	4, 8, 41
Backup Reporting.....	16
Battery.....	34, 38
Battery Drawer.....	8
Battery Life.....	10
Bell.....	6, 7, 41
BR.....	9, 22
Burglary Zones.....	15
Busy-Standby.....	34
Button Transmitters.....	9, 10
Button Type.....	22
Button Zones.....	22
Bypass A Zone.....	33
Bypass Report Code.....	18, 42
Bypass Restore Report Code.....	18, 42

C

CA.....	34
Callback Number.....	20
Cancel Report Code.....	18, 42
Canceled Alarm.....	18
CC.....	34
Chime Mode.....	15, 33
Chime-By-Zone.....	15, 42
Closed Circuit Devices.....	7
Closing Report.....	16
Comm. Failure.....	34
Communication.....	4
Compass Downloader.....	31
Confirmation Of Arming Ding.....	42
Contact ID Event Code 606.....	20
Contact Id Event Codes.....	37
Contact ID Format.....	18, 32, 36, 37, 41
Custom Voice Descriptors.....	20, 30

D

Data Field.....	12
Daylight Saving Time Start/End Month... 15, 42	
Daylight Saving Time Start/End Weekend15, 42	
Default Master Code.....	42
Default Tables.....	42
Delete Entire Zone List?.....	27
Delete Serial Number/Zone Parameters.....	22
Delete Zones.....	27
Delete Zones From List?.....	27
Descriptor 1.....	23, 29
Descriptor 2.....	23, 29
Descriptor 3.....	23, 29
Desktop Mounting.....	5
Device Action.....	26
Device Number.....	26
Device Programming (X-10).....	12
DI.....	34
DIP Switches.....	11
Disarm.....	14, 33
Download Call Back Phone Number.....	20
Download Phone Number.....	42
Downloader.....	19
Downloading.....	31
Duracell MN1500.....	8
Duracell PC1604 Procell.....	8
Duress Code.....	32, 43

E

EA.....	34
Earth Ground.....	6
Enroll Mode.....	23
Enroll Serial Number.....	28
Enroll Zone?.....	28
Entry Delay 01.....	16
Entry Delay 02.....	16
Entry Delay 1.....	42
Entry Delay 2.....	42
Entry/Exit Burglary #1.....	13
Entry/Exit Burglary #2.....	13
Error Code 374.....	18
Event Log.....	4
Event Log 80% Full Report Code.....	19, 42
Event Logging.....	19, 42
Exit Alarm.....	18, 34
Exit Delay.....	15, 16, 42
Exit Door.....	15
Exit Error Feature.....	4
Exit Error Report Code.....	18, 42
Exit Warning.....	16
External Sounder.....	15
External Sounder Connections.....	7

F

Factory Defaults.....	12, 42
Fault.....	34
FC.....	34, 36
FCC Statement.....	40
Fire Sounder Timeout.....	15, 42
First Test Report Offset.....	17, 42
Flexible Callback.....	20, 31, 42
Forced Bypass.....	15, 42
Front Assembly Board.....	5

G

Go/No Go Test Mode.....	10
-------------------------	----

H

Handshake Frequency.....	36
Hardwire Zone.....	4, 6, 22, 43
Hardwired Zone Connections.....	7
HAYES.....	31
House ID.....	9, 11, 15, 25

I

Initial Download.....	31
Input Types.....	9, 22, 43
Installer Code.....	15, 32, 41
Interactive Mode.....	12
Interior W/Delay.....	14
Interior, Follower.....	13

K

Keypad Backlight Timeout.....	15, 42
Keypad Functions.....	33
Keys.....	9
Kissoff Frequency.....	36

L

Local Sounder Disable Jumper.....	6, 7
Loop Number.....	22, 43
Low Bat.....	34
Low Battery Report Code.....	18, 42
Low Battery Restore Report Code.....	19, 42
Low Speed.....	36
Lynx-Dm.....	5

M

Master Security Code.....	15, 32
Memory Of Alarm.....	33
Message Center.....	4, 33
Modem Comm.....	34
Mounting Base.....	5
Mute System Announcements.....	33

N

No Alarm Response.....	14
No Delay.....	33
Number Of Reports In Armed Period.....	20, 42

O

Open Circuit Devices.....	7
Open Report Code.....	18, 42
Optima 24 Plus FAX96 Modem.....	31

P

PABX Access Code.....	16, 42
Pager.....	17, 19, 33
Pager Characters.....	19, 42
Pager Message.....	19
Pager Report Format.....	17
Panic Keys.....	32
Perimeter Burglary.....	13
Periodic Test Report.....	17, 42
Phone Line Connections.....	6, 7
Phone System Select.....	16, 42
Piezo Sounder.....	6, 7, 41
Play Back A Message.....	33
Plug-In Transformer.....	4, 6, 8
Power Failure.....	34
Power Up In Previous State.....	16, 42
Powerline Carrier Device Connections.....	7
Powerline Carrier Device House Code.....	42
Powerline Carrier Device Programming.....	26
Powerline Carrier Devices.....	4, 6, 15, 20, 24, 25, 34, 42
Powerline Interface Module.....	4, 6, 7, 24
Primary Phone Number.....	16, 42
Primary Subscriber Account Number.....	16, 42
Programming Mode.....	12, 15
Pulse Dial.....	16

Q

Quick Arm Enable.....	15, 33, 42
Quick Exit.....	16

R

Radionics.....	17
Radionics/SESCOA.....	41
Range.....	9
Real-Time Clock.....	4, 15, 42
Record A Message.....	30, 33
Record Custom Voice Descriptors.....	12
Remote Programming/Control.....	31
Report Code Formats.....	17, 36, 42
Report Codes.....	17, 22
Response Time.....	7
Restart Exit Delay.....	16, 33
RF.....	9, 22
RF Jam Detection.....	17
RF House ID Code.....	15, 42
RF Transmitter Low Battery Report Code.....	18, 42
RF Transmitter Low Battery Restore.....	42
RF Transmitter Low Battery Restore Code.....	19
Ring Detection Count For Downloading.....	20, 42
RJ11 Jack.....	7
RJ31X Jack.....	7

S

Secondary Phone Number.....	16, 42
Secondary Subscriber Account Number.....	16, 42
Secondary User Codes.....	32
Security Codes.....	15, 32
Security Functions.....	33
Serial Numbers.....	20, 21, 23, 28
Sescoa/Radionics Select.....	17, 36, 42
SH10A.....	26
Signal Strength.....	10
Silent Burglary.....	14
Single Alarm Sounding Per Zone.....	15, 42
Siren/Horn.....	26
Site-Initiated Remote Programming.....	31
Smartmodem 1200.....	31
Smoke Detectors.....	2, 39
Sniffer Mode.....	10, 35, 38
Sounders.....	6
Specifications.....	41
Split/Dual Reporting.....	17, 42
Standby Time.....	8
Start Event Type.....	24, 26
Start Zone List.....	26
Start Zone Type.....	24, 26
Station-Initiated Remote Programming.....	31
Stay Mode.....	33
Stop Recording.....	33
Stop Zone List.....	26
Stop Zone Type.....	26
Supervised Fire.....	14
Supervised RF.....	9, 22
System Battery.....	38
System Communication.....	36
System Features.....	4
System Operation.....	24, 25, 26, 32, 44
System Power.....	4
System Words.....	30

T

Technical Support.....	39
Temporal Pulse.....	15
Test Mode.....	33, 35, 38, 39
Test Report Code.....	18, 42
Test Restore Report Code.....	19, 42
Time And Date.....	33
Tone Dial.....	16
Transmitter Loop Numbers.....	11
Transmitter Supervision.....	9
Trouble Conditions.....	34
Trouble Report Code.....	18, 42
Trouble Restore Report Code.....	18, 42
Troubleshooting Guide.....	38

U

UL985.....	8
Unsupervised Button RF.....	9
Unsupervised RF.....	9, 22
UR.....	9, 22
User Codes.....	4, 33

V

V-LINK® Software.....	4, 19, 31
Vocabulary Index.....	30
Voice Descriptors.....	22, 23, 29
Voltage Input.....	41
Volume Control.....	33

W

Wall Mounting.....	5
WAVE2EX.....	7, 41
Wireless Button Zone.....	4
Wireless Buttons.....	9
Wireless Transmitter.....	18
Wireless Zones.....	9
Wiring Connections.....	7
World Wide Web Address.....	39

X

X-10 Brand.....	24
-----------------	----

Z

Zone 1 Resistance.....	7, 41
Zone Descriptor.....	43
Zone Entry To List.....	27
Zone List Number.....	27
Zone List Programming.....	12, 27
Zone Lists.....	20, 44
Zone Lists For Devices.....	42
Zone Number.....	22, 28, 29
Zone Programming.....	12, 42
Zone Response Type.....	13, 22, 26
Zones And Devices.....	4

WARNING
THE LIMITATIONS OF THIS ALARM SYSTEM

While this System is an advanced design security system, it does not offer guaranteed protection against burglary, fire or other emergency. Any alarm system, whether commercial or residential, is subject to compromise or failure to warn for a variety of reasons. For example:

- Intrusion detectors (e.g., passive infrared detectors), smoke detectors, and many other sensing devices will not work without power. Battery-operated devices will not work without batteries, with dead batteries, or if the batteries are not put in properly. Devices powered solely by AC will not work if their AC power supply is cut off for any reason, however briefly.
- Signals sent by wireless transmitters may be blocked or reflected by metal before they reach the alarm receiver. Even if the signal path has been recently checked during a weekly test, blockage can occur if a metal object is moved into the path.
- A user may not be able to reach a panic or emergency button quickly enough.
- While smoke detectors have played a key role in reducing residential fire deaths in the United States, they may not activate or provide early warning for a variety of reasons in as many as 35% of all fires, according to data published by the Federal Emergency Management Agency. Some of the reasons smoke detectors used in conjunction with this System may not work are as follows. Smoke detectors may have been improperly installed and positioned. Smoke detectors may not sense fires that start where smoke cannot reach the detectors, such as in chimneys, in walls, or roofs, or on the other side of closed doors. Smoke detectors also may not sense a fire on another level of a residence or building. A second floor detector, for example, may not sense a first floor or basement fire. Finally, smoke detectors have sensing limitations. No smoke detector can sense every kind of fire every time. In general, detectors may not always warn about fires caused by carelessness and safety hazards like smoking in bed, violent explosions, escaping gas, improper storage of flammable materials, overloaded electrical circuits, children playing with matches, or arson. Depending on the nature of the fire and/or location of the smoke detectors, the detector, even if it operates as anticipated, may not provide sufficient warning to allow all occupants to escape in time to prevent injury or death.
- Passive Infrared Motion Detectors can only detect intrusion within the designed ranges as diagrammed in their installation manual. Passive Infrared Detectors do not provide volumetric area protection. They do create multiple beams of protection, and intrusion can only be detected in unobstructed areas covered by those beams. They cannot detect motion or intrusion that takes place behind walls, ceilings, floors, closed doors, glass partitions, glass doors, or windows. Mechanical tampering, masking, painting or spraying of any material on the mirrors, windows or any part of the optical system can reduce their detection ability. Passive Infrared Detectors sense changes in temperature; however, as the ambient temperature of the protected area approaches the temperature range of 90° to 105°F (32° to 40°C), the detection performance can decrease.
- Alarm warning devices such as sirens, bells or horns may not alert people or wake up sleepers if they are located on the other side of closed or partly open doors. If warning devices are located on a different level of the residence from the bedrooms, then they are less likely to waken or alert people inside the bedrooms. Even persons who are awake may not hear the warning if the alarm is muffled by noise from a stereo, radio, air conditioner or other appliance, or by passing traffic. Finally, alarm warning devices, however loud, may not warn hearing-impaired people.
- Telephone lines needed to transmit alarm signals from a premises to a central monitoring station may be out of service or temporarily out of service. Telephone lines are also subject to compromise by sophisticated intruders.
- Even if the system responds to the emergency as intended, however, occupants may have insufficient time to protect themselves from the emergency situation. In the case of a monitored alarm system, authorities may not respond appropriately.
- This equipment, like other electrical devices, is subject to component failure. Even though this equipment is designed to last as long as 20 years, the electronic components could fail at any time.

The most common cause of an alarm system not functioning when an intrusion or fire occurs is inadequate maintenance. This alarm system should be tested weekly to make sure all sensors and transmitters are working properly. The security keypad (and remote keypad) should be tested as well.

Wireless transmitters (used in some systems) are designed to provide long battery life under normal operating conditions. Longevity of batteries may be as much as 4 to 7 years, depending on the environment, usage, and the specific wireless device being used. External factors such as humidity, high or low temperatures, as well as large swings in temperature, may all reduce the actual battery life in a given installation. This wireless system, however, can identify a true low battery situation, thus allowing time to arrange a change of battery to maintain protection for that given point within the system.

Installing an alarm system may make the owner eligible for a lower insurance rate, but an alarm system is not a substitute for insurance. Homeowners, property owners and renters should continue to act prudently in protecting themselves and continue to insure their lives and property.

We continue to develop new and improved protection devices. Users of alarm systems owe it to themselves and their loved ones to learn about these developments.

NOTE: Connection of the fire alarm signal to a fire alarm headquarters or a central station shall be permitted with the approval of the local authority having jurisdiction. The burglar alarm signal shall not be connected to a police emergency number.
The System must be checked by a qualified technician once every three years.

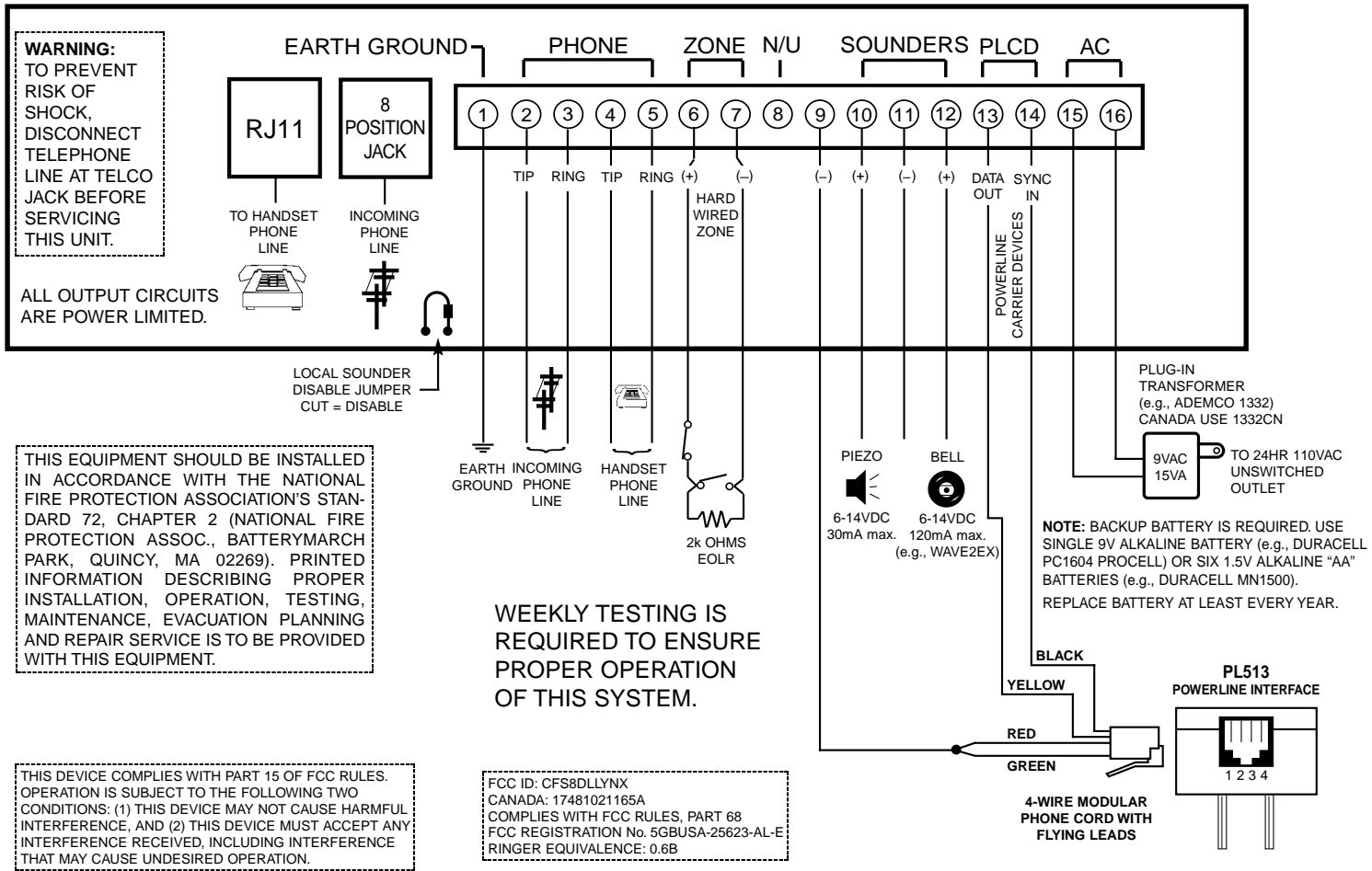

ADEMCO LIMITED WARRANTY

Alarm Device Manufacturing Company, a Division of Pittway Corporation, and its divisions, subsidiaries and affiliates ("Seller"), 165 Eileen Way, Syosset, New York 11791, warrants its products to be in conformance with its own plans and specifications and to be free from defects in materials and workmanship under normal use and service for 24 months from the date stamp control on the product or, for products not having an Ademco date stamp, for 12 months from date of original purchase unless the installation instructions or catalog sets forth a shorter period, in which case the shorter period shall apply. Seller's obligation shall be limited to repairing or replacing, at its option, free of charge for materials or labor, any product which is proved not in compliance with Seller's specifications or proves defective in materials or workmanship under normal use and service. Seller shall have no obligation under this Limited Warranty or otherwise if the product is altered or improperly repaired or serviced by anyone other than Ademco factory service. For warranty service, return product transportation prepaid, to Ademco Factory Service, 165 Eileen Way, Syosset, New York 11791.

THERE ARE NO WARRANTIES, EXPRESS OR IMPLIED, OF MERCHANTABILITY, OR FITNESS FOR A PARTICULAR PURPOSE OR OTHERWISE, WHICH EXTEND BEYOND THE DESCRIPTION ON THE FACE HEREOF. IN NO CASE SHALL SELLER BE LIABLE TO ANYONE FOR ANY CONSEQUENTIAL OR INCIDENTAL DAMAGES FOR BREACH OF THIS OR ANY OTHER WARRANTY, EXPRESS OR IMPLIED, OR UPON ANY OTHER BASIS OF LIABILITY WHATSOEVER, EVEN IF THE LOSS OR DAMAGE IS CAUSED BY THE SELLER'S OWN NEGLIGENCE OR FAULT.

Seller does not represent that the products it sells may not be compromised or circumvented; that the products will prevent any personal injury or property loss by burglary, robbery, fire or otherwise; or that the products will in all cases provide adequate warning or protection. Customer understands that a properly installed and maintained alarm may only reduce the risk of a burglary, robbery, fire or other events occurring without providing an alarm, but it is not insurance or a guarantee that such will not occur or that there will be no personal injury or property loss as a result. CONSEQUENTLY, SELLER SHALL HAVE NO LIABILITY FOR ANY PERSONAL INJURY, PROPERTY DAMAGE OR OTHER LOSS BASED ON A CLAIM THE PRODUCT FAILED TO GIVE WARNING. HOWEVER, IF SELLER IS HELD LIABLE, WHETHER DIRECTLY OR INDIRECTLY, FOR ANY LOSS OR DAMAGE ARISING UNDER THIS LIMITED WARRANTY OR OTHERWISE, REGARDLESS OF CAUSE OR ORIGIN, SELLER'S MAXIMUM LIABILITY SHALL NOT IN ANY CASE EXCEED THE PURCHASE PRICE OF THE PRODUCT, WHICH SHALL BE THE COMPLETE AND EXCLUSIVE REMEDY AGAINST SELLER. This warranty replaces any previous warranties and is the only warranty made by Seller on this product. No increase or alteration, written or verbal, of the obligations of this Limited Warranty is authorized.

ADEMCO
GROUP

165 Eileen Way, Syosset, New York 11791
Copyright © 1998 PITTWAY CORPORATION



N8889V1 10/98